

**TOSHIBA**

DIGITAL COLOUR PLAIN PAPER COPIER

**OPERATOR'S MANUAL  
FOR COPYING FUNCTIONS**

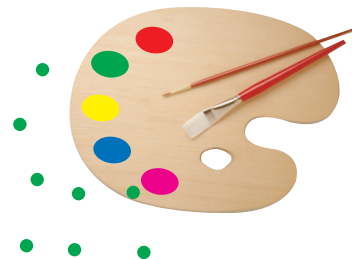

**FC15/22**



**WARNING:** Changes or modification made to this equipment, not expressly approved by Toshiba TEC or parties authorized by Toshiba TEC could void the user's authority to operate the equipment.

## **Storage of Colour Copies**

- (1) The copies should be kept in a place which is not exposed to light to prevent fading when they are stored for a long time.
- (2) If copies are kept pressed between plastics made of chloroethylene for a long time, the toner may melt and stick to the plastic due to high pressure and high temperature. Keep them in polythene binders.
- (3) When a colour copy is folded, the toner at the fold can become separated.
- (4) The toner on the copies may melt if it touches solvent. If the ink on the copies is not dried completely, the toner may also melt. Keep copies away from solvent.
- (5) When copies are kept near an extremely high temperature such as a heater, the toner may melt. Keep them under room temperature which does not vary very much.

## **Forgery Prevention Function**

This copier has a forgery prevention function.

Please ensure that your digital full colour copier is not used for making copies of prohibited items.

# PREFACE

Thank you for purchasing the Toshiba Digital Colour Copier FC15/22. This Operator's Manual describes the following:

- how to use the digital colour copier
- how to inspect and carry out maintenance on the digital copier
- how to remedy mechanical and copying problems.

Before using the digital colour copier, thoroughly read and understand the Operator's Manual. To ensure that clean copies are made at all times and to make sure that the digital colour copier is in optimum working order, keep this Operator's Manual in a handy place for future reference.

- To ensure correct and safe use of the Toshiba Digital Colour Copier FC15/22, this Operator's Manual describes safety precautions according to the following three levels of warning:

The meanings of these signal words are as follows. Before reading this Operator's Manual, you should fully understand the meaning and importance of these signal words.

**Warning** ----- Indicates a potentially hazardous situation which, if not avoided, could result in death or serious injury, or serious damage or fire in the equipment or surrounding assets.

**Caution** ----- Indicates a potentially hazardous situation which, if not avoided, may result in minor or moderate injury, partial damage of the equipment or surrounding assets, or loss of data.

**Note** ----- Indicates a procedure you should follow to ensure the optimal performance of the digital colour copier and problem-free copying.

**Tip** ----- Describes handy information useful to know when operating the digital colour copier.

**Advice** ----- Describes an operation you should follow to maintain the digital colour copier in good working order.

## Warning

**This is a Class A product. In a domestic environment this product may cause radio interference in which case the user may be required to take adequate measures.**

1. Do not touch the connector terminal when disconnecting the cables of peripheral equipment.
2. Before opening any covers or removing any units from the copier, discharge the static electricity from your body by touching a metal part of the copier.

This product is carrying the CE-Mark in accordance with the related European Directives. Responsible for CE-marking is Toshiba Europe GmbH, Hammfelddamm 8,41460 Neuss, Germany. Phone +49-2131-158-01.

# PREFACE (Cont.)

## Features of the FC15/22

The FC15/22 is a plain paper digital colour copier.

The FC15/22 allows you not only to process and edit these digital image data, but also enables copies to be sorted and grouped quietly, quickly and easily. The FC15/22 incorporates a large-size display with a touch panel and menu keys that graphically represent copier functions. As a result, anybody can make clear-looking copies quickly and easily.

The FC15/22 also has the following convenient features.

- The first copy is output in 10.3 seconds.
- Full-colour copying speed is 15/22 copies (A4) per minute.
- The original developed 4-beam laser optical unit allows for a compact copier.
- The latest image processing technology reproduces high-resolution real colour.
- A fixing system with less oil reduces the amount of oil stuck to the paper which improves the transparency of the OHP film.
- Comes with the following digital editing functions:  
Trimming, masking, negative/positive reversal, full image, image repeat and mirror image.
- Copy sizes from A5 up to A3 are acceptable. Special paper such as thick paper (60~209g/m<sup>2</sup>), OHP films, labels and A3-wide paper (304.8mm x 457.2mm) are also acceptable as copy sizes.

### Options

- By installing the optional reversing automatic document feeder and automatic duplexer, duplex copies or single-sided copies can be made automatically from two-sided originals. Duplex copies can also be made automatically from single-sided originals.
- Adding the optional 20-bin staple sorter permits the quick stapling and sorting of copies.
- The optional advance image enhancement mode automatically analyses the original to optimally reproduce text, illustrations and photographs.
- Installing an optional printer unit allows additional functions such as scanning images by the copier and printing out data from the PCs.

If an optional printer controller is installed, this copier can be used as a colour printer or scanner also.

For purchasing the printer controller, please ask your service centre or distributor.

# TABLE OF CONTENTS

■ PREFACE .....	1
■ TABLE OF CONTENTS .....	3
■ PRECAUTIONS .....	5
1. INSTALLATION .....	5
2. GENERAL PRECAUTIONS .....	6

<b>1. DESCRIPTION OF THE DIGITAL COPIER .....</b>	<b>7</b>
1. NAMES OF THE MAIN COMPONENTS .....	8
2. DESCRIPTION OF THE OPTIONAL EQUIPMENT .....	9
3. DESCRIPTION OF THE CONTROL PANEL .....	10
4. DESCRIPTION OF THE MESSAGE DISPLAY .....	13
5. DESCRIPTION OF THE GRAPHIC DISPLAY .....	15

<b>2. HOW TO MAKE COPIES .....</b>	<b>17</b>
1. PAPER .....	18
2. ENERGY-SAVING FUNCTION .....	20
3. TURNING ON THE POWER SWITCH/AUTO JOB START .....	21
4. USING THE REVERSING AUTOMATIC DOCUMENT FEEDER (OPTIONAL) .....	24
5. COPYING IN THE AUTOMATIC PAPER SELECTION MODE .....	28
6. REDUCTION AND ENLARGEMENT COPYING .....	32
7. COPYING WITH COPY DENSITY SELECTION .....	36
8. COPYING BY ORIGINAL MODE SELECTION .....	38
9. COLOUR MODE .....	40
10. BYPASS COPYING (THICK PAPER/OHP FILM) .....	41
11. CASSETTE SETTING FOR THICK PAPER/OHP FILM .....	47
12. INTERRUPT COPYING .....	49

<b>3. COLOUR EDITING AND ADJUSTMENT .....</b>	<b>51</b>
1. MONOCOLOUR COPYING .....	52
2. HUE ADJUSTMENT .....	53
3. SATURATION .....	54
4. COLOUR BALANCE (YMCK ADJUSTMENT) .....	55
5. RGB ADJUSTMENT .....	56
6. ONE-TOUCH ADJUSTMENT .....	57
7. BACKGROUND ADJUSTMENT .....	58
8. SHARPNESS ADJUSTMENT .....	59

<b>4. USING THE EDITING FUNCTIONS .....</b>	<b>61</b>
1. IMAGE SHIFT COPYING .....	62
2. EDGE ERASE COPYING .....	64
3. BOOK CENTRE ERASE .....	66
4. DUAL-PAGE COPYING .....	68
5. FULL IMAGE COPYING .....	70
6. 2 IN 1 MODE COPYING .....	71
7. DUPLEX COPYING .....	73
① DUPLEXED COPIES FROM SINGLE-SIDED ORIGINALS .....	73
② DUPLEXED COPIES FROM TWO-SIDED ORIGINALS .....	77
③ SINGLE-SIDED COPIES FROM TWO-SIDED ORIGINALS .....	78
④ DUPLEXED COPIES FROM BOOK ORIGINALS .....	79
8. X-Y ZOOM .....	82
9. TRIMMING/MASKING .....	83

PREFACE  
CONTENTS  
PRECAUTIONS

DESCRIPTION  
OF THE DIGITAL  
COPIER

HOW TO  
MAKE  
COPIES

COLOR EDITING AND  
ADJUSTMENT

USING THE  
EDITING  
FUNCTIONS

USING THE  
SPECIAL  
FUNCTIONS

USING THE  
OPTIONAL  
SORTER

WHEN THE  
GRAPHIC SYMBOLS  
FLASH

MAINTENANCE

SPECIFICATIONS,  
ACCESSORIES &  
OPTIONS

# TABLE OF CONTENTS (Cont.)

10. MIRROR IMAGE .....	87
11. NEGATIVE/POSITIVE REVERSAL .....	88
12. CENTRING .....	89
13. IMAGE REPEAT .....	91

<b>5. USING THE SPECIAL FUNCTIONS .....</b>	<b>93</b>
1. AUTOMATIC CALIBRATION .....	94
2. SETTING THE DATE AND TIME .....	97
3. WEEKLY TIMER .....	99
4. MODE MEMORY .....	101
5. COPYING USING PAPER OF UNIVERSAL SIZES .....	103
6. ACCESS CODES (ID NUMBERS) .....	107
7. TOTAL COUNTER .....	108
8. DEPARTMENT MANAGEMENT .....	109
9. KEY COPY COUNTER .....	117
10. CHANGE OF LANGUAGE ON THE DISPLAY PANEL .....	118
11. USER SELECTION (INITIAL SETTINGS) .....	119

<b>6. USING THE OPTIONAL STAPLE SORTER .....</b>	<b>121</b>
1. DESCRIPTION OF THE MAIN COMPONENTS .....	122
2. NON-SORT COPYING .....	123
3. SORT OR STAPLE SORT COPYING .....	124
4. GROUP COPYING .....	128

<b>7. WHEN THE GRAPHIC SYMBOLS FLASH .....</b>	<b>129</b>
1. ADD PAPER SYMBOL .....	130
2. REPLACE TONER BAG SYMBOL .....	134
3. ADD TONER SYMBOL .....	136
4. CLEAR PAPER SYMBOL .....	138
① MISFEEDING INSIDE OF THE COPIER .....	138
② MISFEEDING IN THE AUTOMATIC DUPLEXER .....	143
③ MISFEEDING FROM THE CASSETTES .....	145
MISFEEDING IN THE LARGE-CAPACITY FEEDER .....	146
④ MISFEEDING IN THE AUTOMATIC DOCUMENT FEEDER .....	147
⑤ MISFEEDING IN THE BYPASS GUIDE .....	148
⑥ MISFEEDING IN THE STAPLE SORTER .....	149
5. REPLACING STAPLES .....	150
6. REMOVING JAMMED STAPLES .....	152
7. CALL SERVICE SYMBOL .....	154
8. PERIODIC MAINTENANCE .....	154

<b>■ MAINTENANCE .....</b>	<b>155</b>
1. DAILY INSPECTION .....	156
2. SIMPLE TROUBLESHOOTING .....	157

<b>■ SPECIFICATIONS, ACCESSORIES &amp; OPTIONS .....</b>	<b>159</b>
1. FC15/22 SPECIFICATIONS .....	160
2. SPECIFICATIONS OF OPTIONS .....	161
3. PACKING LIST .....	163
4. COPYING FUNCTION COMBINATION MATRIX .....	164
5. IMAGE QUALITY ADJUSTMENT COMBINATION MATRIX .....	165



# PRECAUTIONS

## 1. INSTALLATION

- 1** The FC15/22 should be installed by a qualified service technician.  
**Note:** The packing material should be disposed of properly.

- 2** To obtain the best possible results, this copier should be used in conjunction with a dedicated AC power line at the following ratings:  
220-240 V, 50/60 Hz, 9 A

**Notes:**

1. The use of other appliances or other equipment on the same line as this copier may adversely affect performance and copy quality.
2. Be sure to use a 3-conductor, grounded wall outlet.
3. In areas where a 2-pin plug is used, the copier must be grounded for safety.  
Never ground it to a gas pipe, a water pipe, or any other object not suitable for grounding.

- 3** After a suitable place has been selected for the installation for the FC15/22, please do not change it. Avoid excessive heat, dust, vibration and direct sunlight. Also, provide proper ventilation as the copier emits a slight amount of ozone.

**Notes:**

1. Recommended environmental range for use is as follows:
  - Temperature: 10~30°C/50~86°F
  - Humidity: 20~80%RH
2. To insure optimal operation, allow clearances of at least 80cm on the left, 80cm on the right and 10cm in the rear.

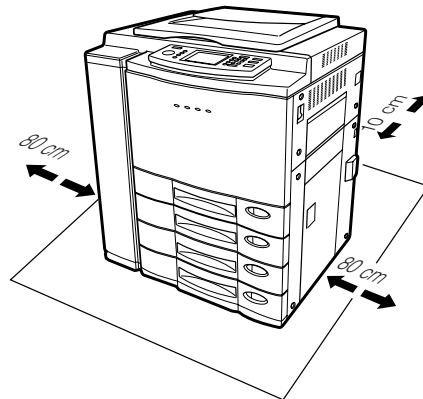

The copier should be located near a wall outlet which should be easily accessible.

# PRECAUTIONS (Cont.)

## 2. GENERAL PRECAUTIONS

- 1 Handle and use the copier gently and carefully.**
  - Do not place anything on the paper cassettes or original feed tray.
  - Never allow the power cable to be trampled on or pinched between hard objects, otherwise an accident or electrical trouble might occur.
  - Do not allow any metal things such as paper clips to fall into the copier.
  
- 2 Be sure to turn OFF the power switch (unless using automatic timer mode):**
  - When you leave your office at night.
  - If a power failure occurs.

**Caution: When turning OFF the power switch, be sure to do so only after the machine cycling has come to a complete stop.**

**Be sure to disconnect the power-cord plug:**

  - when you do not intend to use the copier for an extended period of time such as during weekends or the summer vacation.

**Be sure to turn OFF the power switch immediately and call for service:**

  - If an unusual noise is heard from the copier.
  - If the outside of the copier becomes unusually hot.
  - If any part of this copier is damaged, or if it has been dropped.
  - If the copier has been exposed to rain or liquid.
  
- 3 It is recommended that only supplies made or designated by Toshiba be used for the FC15/22 in order to optimize copy quality. All supplies should be stored in a cool, dry area.**

Paper of lower quality may contain inherent properties such as excess paper dust and may lead to premature servicing.



DO NOT LEAN ON, APPLY FORCE OR PLACE HEAVY OBJECTS ON SORTER. PERSONAL INJURY OR PROPERTY DAMAGE MAY RESULT.

### Machine Noise Information

Ordinance 3. GSGV, January 18, 1991: The maximum sound pressure level is equal or less than 70 dB(A) according to EN27779.

# 1. DESCRIPTION OF THE DIGITAL COPIER

1. Names of the Main Components . . . . .	8
2. Description of the Optional Equipment . . . . .	9
3. Description of the Control Panel . . . . .	10
4. Description of the Message Display . . . . .	13
5. Description of the Graphic Display . . . . .	15

# 1. NAMES OF THE MAIN COMPONENTS

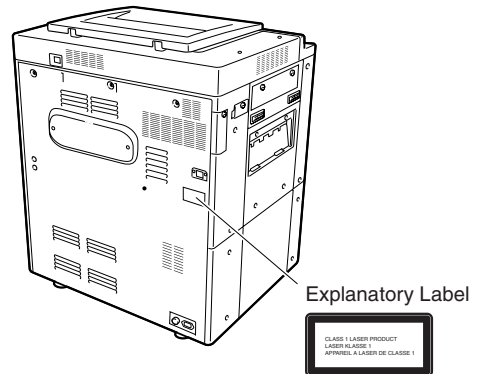
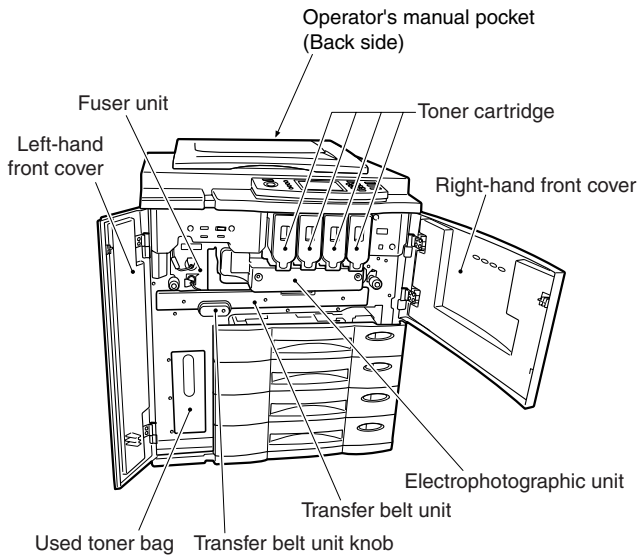
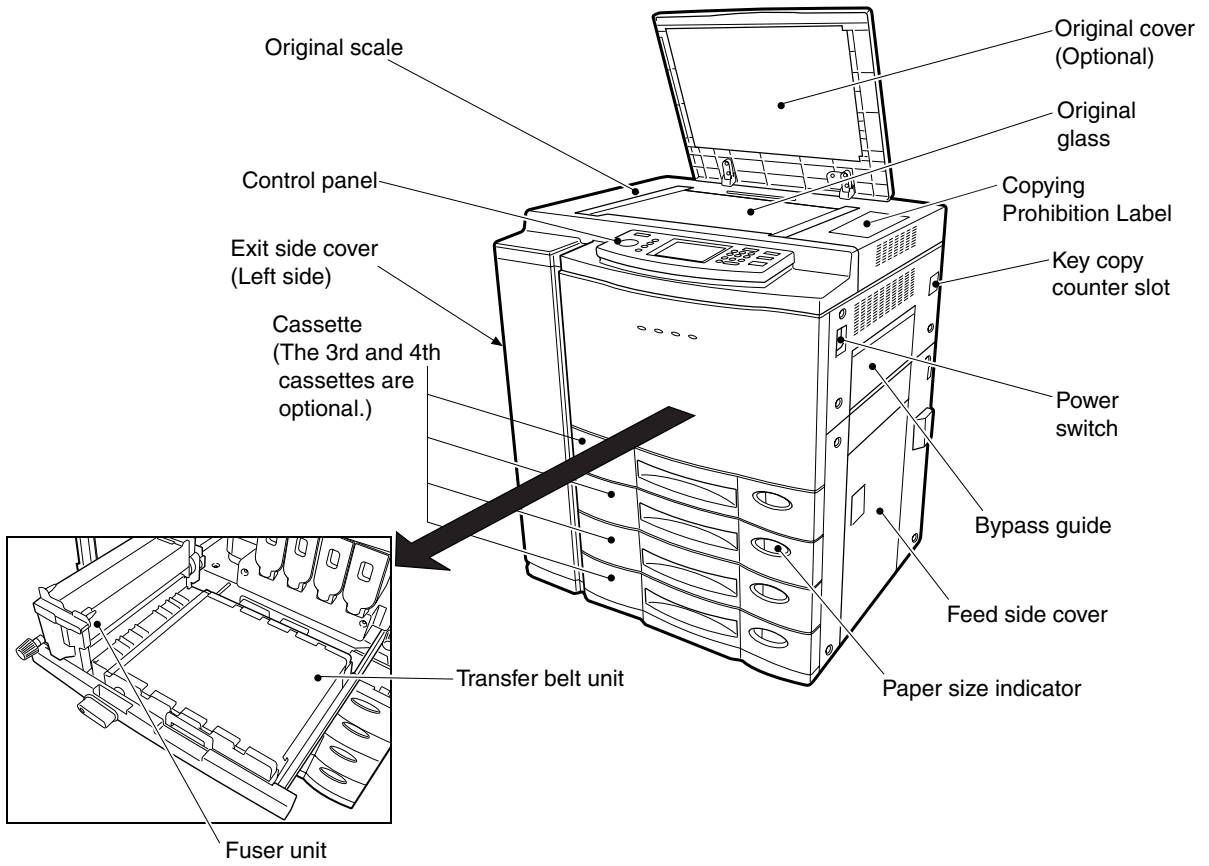

## 2. DESCRIPTION OF THE OPTIONAL EQUIPMENT

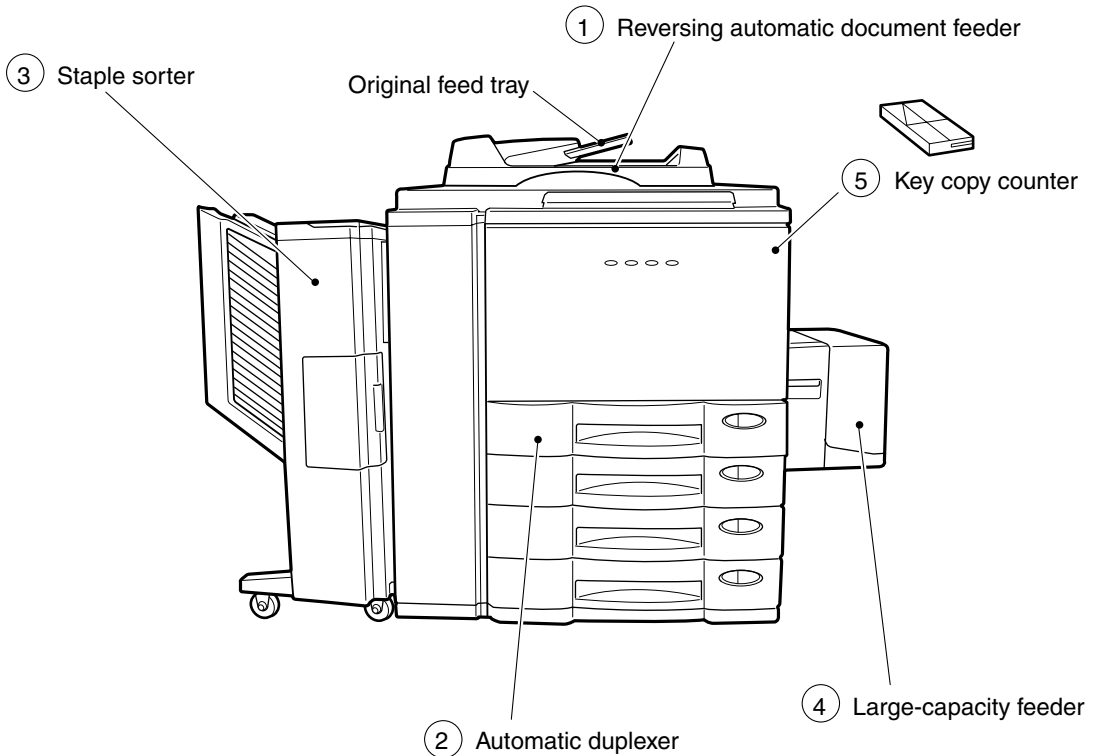

### ① Reversing Automatic Document Feeder

A set of originals can automatically be fed one by one to make copies.

### ② Automatic Duplexer

This reverses the copies in order to make duplex copies.

### ③ Staple Sorter

Up to 20 sets of copies can be automatically sorted. There are the following three modes.

- Sort : The copies can be sorted in the same order as the originals.
- Group : The same pages can be sorted in the same bins.
- Sort/Staple : Each set can be sorted and stapled respectively.

### ④ Large-Capacity Feeder

You will have an additional paper source which can hold up to 1500 sheets of A4-sized paper (80 g/m<sup>2</sup>).

### ⑤ Key Copy Counter

Copies made are recorded (added) according to particular individuals or groups.

# 3. DESCRIPTION OF THE CONTROL PANEL

- ① **MECHANICAL COUNTER**  
The total number of copies (converted into Letter size) made after the installation of the copier is shown here.

---

- ② **TIMER lamp**  
This lamp lights during the use of the timer.

---

- ③ **INFO key**  
Use this key to display the appropriate operation procedure.

---

- ④ **SETTINGS key**  
The current copy modes or an editing function list are shown with the corresponding icons. See page 12.

- ⑤ **ENERGY SAVER key**  
When you are not going to use the copier for a long period of time, press this key. The copier enters the energy-saving mode and all display lamps go out. To resume copying, press this key again. The copier becomes ready for copying after a while. (See page 20)

---

- ⑥ **INTERRUPT key**  
When you want to make a copy of a different original during a multicopy run, press this key. During interrupt copying, copies can be made only one by one. To return to the previous multicopy run, press this key again.

- ⑦ **Touch panel**  
The status of the copier, operation procedures and various instructions to the user are shown in the pictorials and text.

---

- ⑧ **COLOUR SAMPLE SEAL**  
This seal shows samples of the monocolour mode.

---

- ⑨ **ACCESS key**  
Press this key to administer the users of the copier by the access code. Press this key again when you finish making copies so that the next person must enter his/her own access code to make the copier available again. (See page 107)

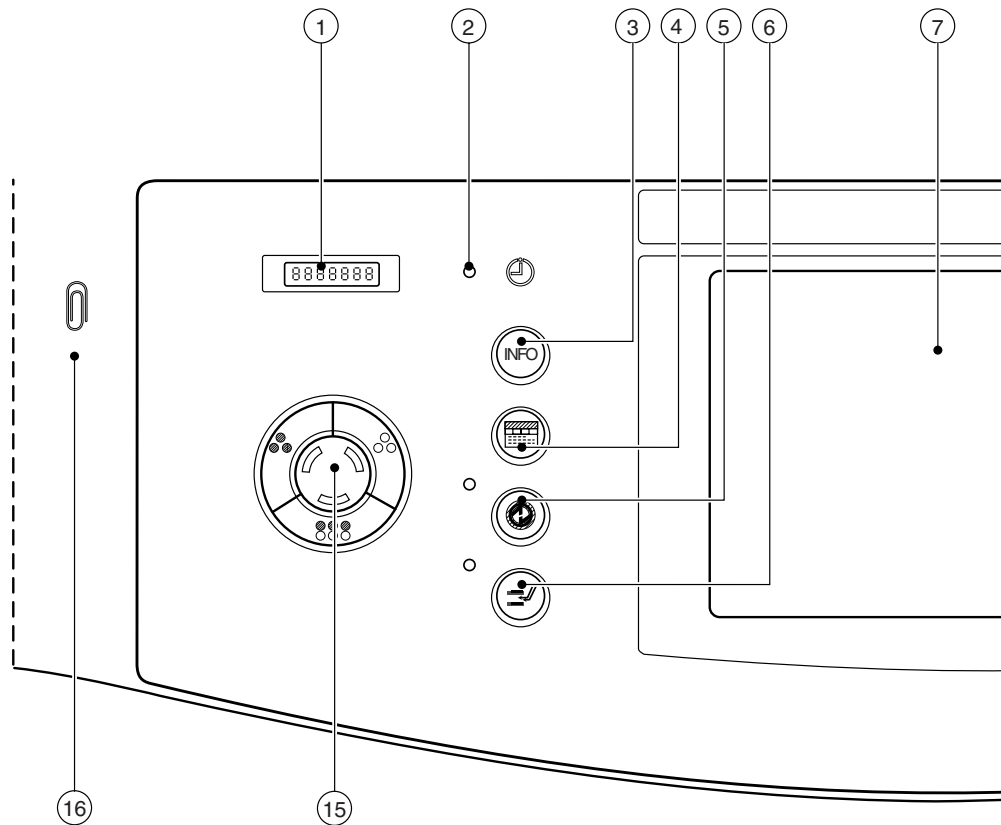

**⑩ FUNCTION CLEAR key**

When you press this key, all the modes you have selected will be cleared to the default copy status.

**⑪ STOP key**

Press this key to stop a multicopy run.

**⑫ START key**

Press this key to start copying.

**⑬ CLEAR key**

Use this key to correct the entered copy quantity.

**⑭ DIGITAL keys**

Use these keys to enter the desired copy quantity. Up to 999 copies can be set.

**⑮ COLOUR MODE SELECTION key**• **AUTO COLOUR**:

The type of original is automatically recognized. Coloured originals are colour-copied and monocolour originals are copied in monocolour.

• **FULL COLOUR**:

Regardless of colour, all originals are colour-copied.

• **BLACK**:

Regardless of colour, all originals are copied in monocolour.

**⑯ CLIP TRAY**

Put any paper clips removed from the originals here for safe keeping.

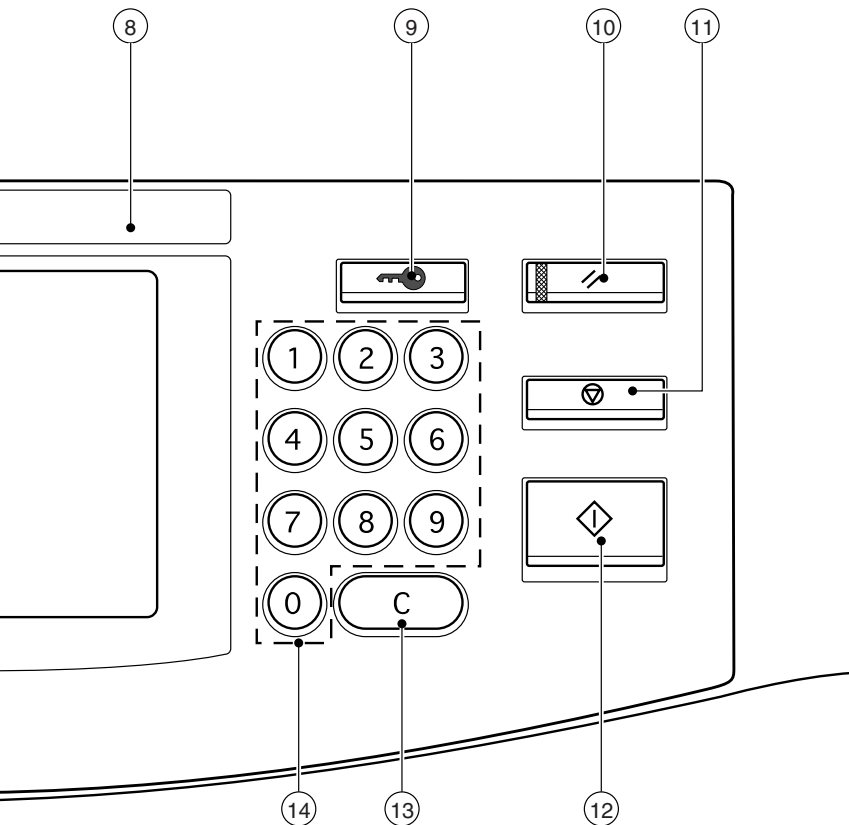

# 3. DESCRIPTION OF THE CONTROL PANEL(Cont.)

## SETTINGS CONFIRMATION function

- If you press the SETTINGS key , the screen on the right will appear.

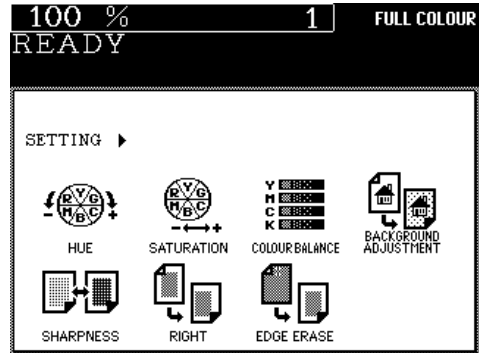

The icons displayed on the screen are as follows (some icons may not appear on the screen):

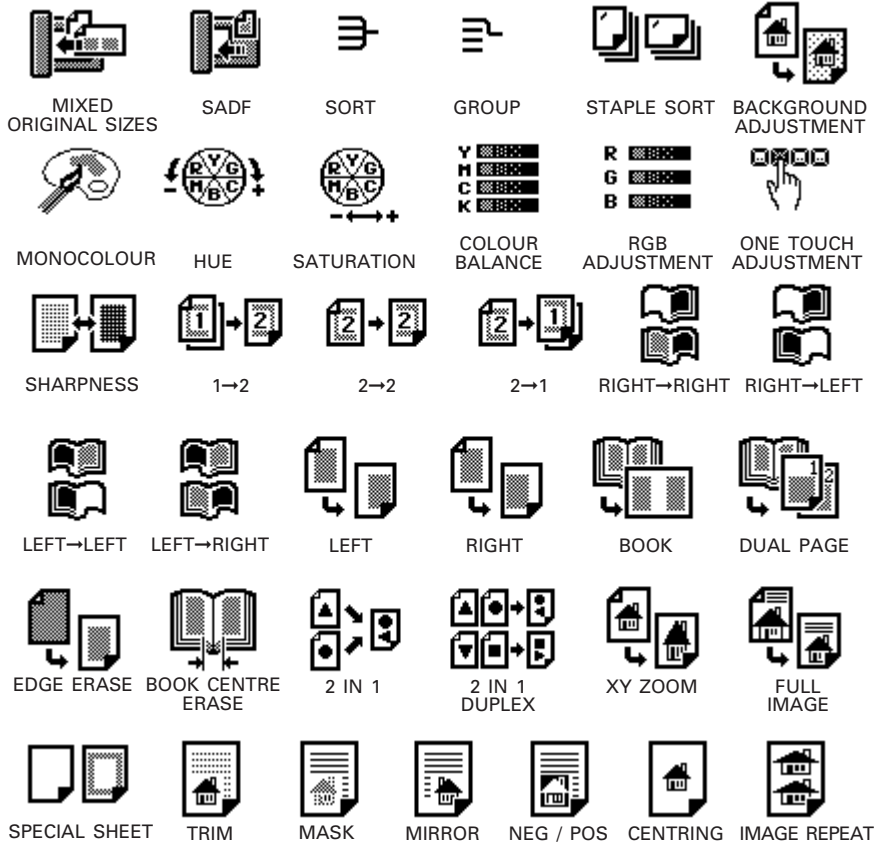



# 4. DESCRIPTION OF THE MESSAGE DISPLAY

The Message Display panel shows the operation state, error messages and function menus.

- Each icon displayed is shown in the form of a touch key. You can select the function by touching the key lightly with your finger.
- Turning ON the power switch will show the Basic menu.  
The function items shown on the right can be selected directly on the Message Display panel.

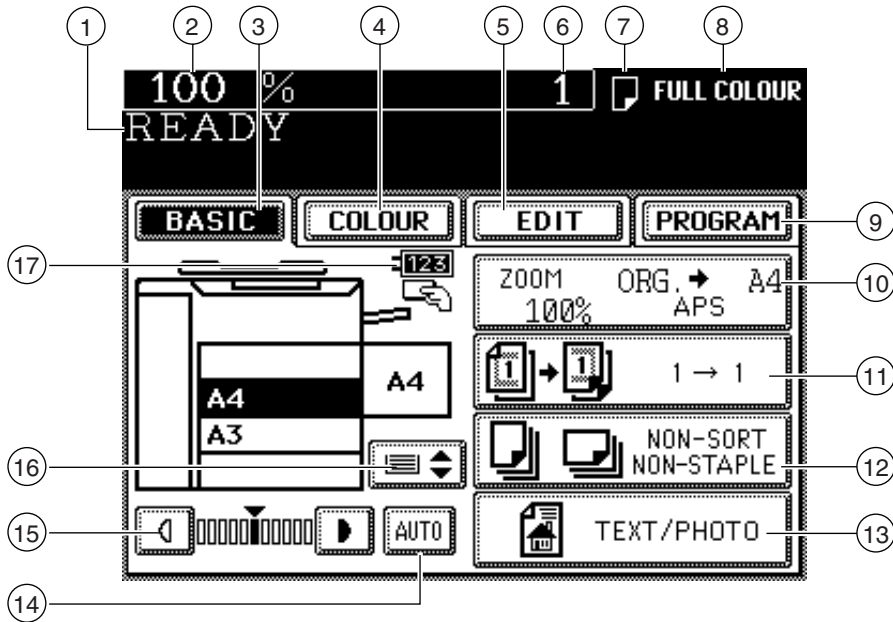

- ① **Message**  
The current status of the copier appears here.
- ② **Reproduction ratio**  
The selected reproduction ratio appears here.
- ③ **BASIC** key  
There are setting menus of copy forms, duplex copying, sort and original modes.  
Use this key to return to the BASIC screen. (See “2. How to make copies” on page 17.)
- ④ **COLOUR** key  
Use this key to select :  
MONOCOLOUR (Page 52)  
HUE/SATURATION (Page 53,54)  
COLOUR BALANCE (YMCK ADJUSTMENT) (Page 55)  
RGB ADJUSTMENT (Page 56)  
ONE-TOUCH ADJUSTMENT (Page 57)  
BACKGROUND ADJUSTMENT (Page 58)  
SHARPNESS (Page 59)
- ⑤ **EDIT** key  
Use this key to select :  
IMAGE SHIFT (Page 61)  
EDGE ERASE (Page 62)  
BOOK CENTRE ERASE (Page 66)
- DUAL PAGE (Page 68)  
FULL IMAGE (Page 70)  
2 IN 1 (Page 71)  
2 IN 1 DUPLEX (Page 71)  
XY ZOOM (Page 82)
- EDITING  
TRIMMING/MASKING (Page 83)  
MIRROR IMAGE (Page 87)  
NEGATIVE/POSITIVE REVERSAL (Page 88)  
CENTRING (Page 89)  
IMAGE REPEAT (Page 91)
- ⑥ **Copy Quantity**  
The number of copies entered with the digital keys is displayed here.
- ⑦ **Copy Paper Type**  
The icon of the selected mode is displayed when thick or transparent paper is selected.



# 4. DESCRIPTION OF THE MESSAGE DISPLAY(Cont.)

- ⑧ **Colour Mode**  
The selected colour mode (AUTO COLOUR, FULL COLOUR, BLACK or MONOCOLOUR) is displayed here.
- ⑨ **PROGRAM key**  
Use this key to select:  
AUTOMATIC DOCUMENT FEEDER (Page 24)  
MIXED ORIGINAL SIZES (Page 27)  
BYPASS FEED (Page 41)  
THICK PAPER (Page 47)  
CALIBRATION (Page 94)  
DATE/TIME (Page 97)  
WEEKLY TIMER (Page 99)  
MODE MEMORY (Page 101)  
UNIVERSAL (Page 103)  
TOTAL COUNTER (Page 108)  
DEPT.MANAGEMENT (Page 109)  
CHANGE LANGUAGES (Page 118)  
USER SELECTION (Page 119)
- ⑩ **Copy Form key**  
Use this key to set reproduction, copy size, etc.
- ⑪ **Duplexed Copy key**  
Use this key to make 2-sided copies from 2-sided (or book) or 1-sided originals. You can also make 1-sided copies from 2-sided originals. (Page 73)
- ⑫ **SORT/STAPLE Setting key**  
Use this key to select the sort, group and stapling modes. An optional sorter must be installed to display this key. (Page 121)
- ⑬ **Original Mode Selection key**  
Use this key to select the suitable copy mode for the originals.
- ⑭ **AUTO key**  
Use this key to make the copier automatically detect the density and background of the original and determine the optimum copy density.
- ⑮ **Manual Density Selection key**  
Press the keys of both sides to change the copy density.
- ⑯ **Cassette Switch key**  
Use this key to switch cassette (including sheet bypass).  
\*Pressing the desired cassette on the Message Display panel will also select the cassette.
- ⑰ **KEY COPY COUNTER symbol**  
This symbol flashes when the optional copy counter is not inserted in the copier.  
Insert it to make copies. (Page 117)

## How to Cancel the Selected Functions

- Pressing the selected (shaded) key once again clears the function you have selected (excluding some functions).
- Pressing nothing will also clear the settings to the default mode by the automatic clear function.

## Automatic Function Clear Mode

- If you do not press the START key within about 45 seconds after having set the desired copy modes, the functions you have selected are automatically cleared to the default mode.
- While the Department Management function is being operated, the display returns to the access code input screen (See page 107).

# 5. DESCRIPTION OF THE GRAPHIC DISPLAY

The graphic on the Message Display panel shows the status of the copier. When one of the graphic symbols flashes, take the appropriate action referring to the page shown.

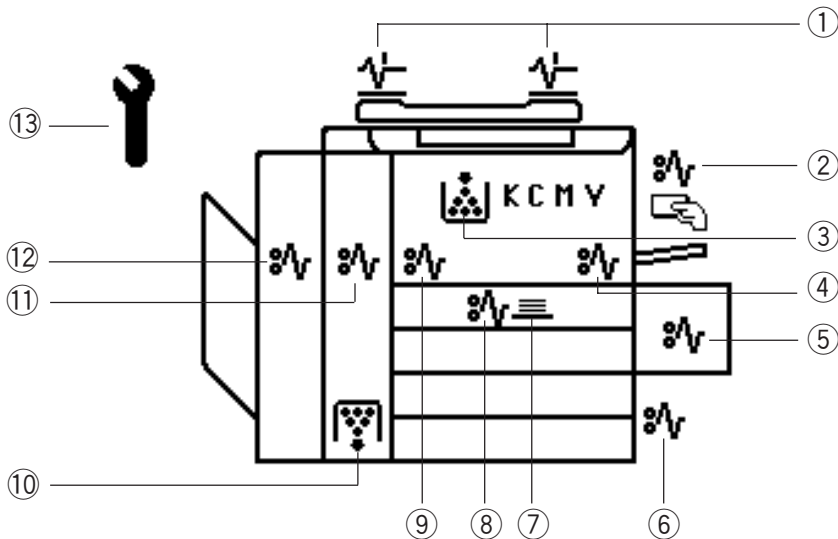

- ① **CHECK ORIGINAL symbol**  
This symbol flashes when an original is misfed inside the automatic document feeder. (Page 147)
- ② **BYPASS MISFEED symbol**  
This symbol flashes when no paper is fed into the copier in bypass copying. Remove and reset the sheets on the sheet bypass. (Page 148)
- ③ **ADD TONER symbol**  
This symbol flashes when the toner supply in the cartridge runs out. (Page 136)
- ④ **CLEAR PAPER symbol**  
This symbol flashes when paper is misfed on the paper path inside the copier. (Page 138)
- ⑤ **CLEAR PAPER symbol**  
This symbol flashes when a sheet of paper fed from the large-capacity feeder is misfed in the paper feed section. (Page 146)
- ⑥ **CLEAR PAPER symbol**  
This symbol flashes when a sheet of paper fed from the selected cassette is misfed in the paper feeding section. (Page 145)
- ⑦ **STACK symbol**  
This symbol flashes when sheets of paper copied on one side are stacked in the duplexer. This symbol also flashes when sheets of paper are left in the duplexer. In this case, remove paper from the duplexer.
- ⑧ **CLEAR PAPER symbol**  
This symbol flashes when paper is misfed in the automatic duplexer. (Page 143)
- ⑨ **CLEAR PAPER symbol**  
This symbol flashes when paper is misfed on the transfer belt. (Page 138)
- ⑩ **REPLACE TONER BAG symbol**  
This symbol flashes when the toner bag becomes full of used toner. (Page 134)
- ⑪ **CLEAR PAPER symbol**  
This symbol flashes when paper is misfed in the fuser unit. (Page 138)
- ⑫ **SORTER MISFEED symbol**  
This symbol flashes when paper is misfed in the optional staple sorter. (Page 149)
- ⑬ **CALL SERVICE symbol**  
This symbol flashes when maintenance by a service technician is necessary. (Page 154)



## 2. HOW TO MAKE COPIES

1. Paper . . . . .	18
2. Energy-Saving Function . . . . .	20
3. Turning ON the Power Switch/ Auto Job Start . . . . .	21
4. Using the Reversing Automatic Document Feeder (Optional) . . . . .	24
5. Copying in the Automatic Paper Selection Mode . . . . .	28
6. Reduction and Enlargement Copying . . . . .	32
7. Copying with Copy Density Selection . . . . .	36
8. Copying by Original Mode Selection . . . . .	38
9. Colour Mode . . . . .	40
10. Bypass Copying (Thick Paper/OHP Film) . . . . .	41
11. Cassette Setting for Thick Paper/OHP Film . . . . .	47
12. Interrupt Copying . . . . .	49

# 1. PAPER

## Acceptable Paper Types and Sizes

Refer to the list below for the acceptable paper.

Use the recommended paper for optimum copy quality.

Feeder	Paper Type	Paper Size	Maximum Capacity	Remarks
1st Cassette	Plain paper	(Standard size) A3,A4,A4-R,A5-R,B4,B5,B5-R, FOLIO(210X330mm),	600 sheets(80g/m <sup>2</sup> ) 500 sheets(90g/m <sup>2</sup> )	This is not available as a paper source when the duplexer is installed.
		LD(11"X17"),LG(8.5"X14"), LT(11"X8.5"),LT-R(8.5"X11"), ST-R(5.5"X8.5"), COMP(10•1/8"X14")	600 sheets(80g/m <sup>2</sup> ) 500 sheets(90g/m <sup>2</sup> )	
2nd Cassette	THICK1 (91-105g/m <sup>2</sup> )	COMP(10•1/8"X14")	400 sheets (105g/m <sup>2</sup> )	*1
	OHP film	(Standard size) A4	100 sheets	Paper cannot be placed in the A4-R direction.
	Plain paper	(Standard size) A3,A4,A4-R,A5-R,B4,B5,B5-R, FOLIO(210X330mm),	600 sheets(80g/m <sup>2</sup> ) 500 sheets(90g/m <sup>2</sup> )	
3rd Cassette	THICK1 (91-105g/m <sup>2</sup> )	LD(11"X17"),LG(8.5"X14"), LT(11"X8.5"),LT-R(8.5"X11"), ST-R(5.5"X8.5"), COMP(10•1/8"X14")	400 sheets (105g/m <sup>2</sup> )	*1
	Plain paper	(Standard size) A3,A4,A4-R,A5-R,B4,B5,B5-R, FOLIO(210X330mm),	600 sheets(80g/m <sup>2</sup> ) 500 sheets(90g/m <sup>2</sup> )	
4th Cassette	THICK1 (91-105g/m <sup>2</sup> )	COMP(10•1/8"X14")	400 sheets (105g/m <sup>2</sup> )	*1
	Plain paper	(Standard size) A3,A4,A4-R,A5-R,B4,B5,B5-R, FOLIO(210X330mm),	50 sheets (80g/m <sup>2</sup> ) 40 sheets (90g/m <sup>2</sup> )	
Sheet Bypass	THICK1 (91-105g/m <sup>2</sup> )	A3-wide(12"X18"), LD(11"X17"),LG(8.5"X14"), LT(11"X8.5"),LT-R(8.5"X11"),	30 sheets	*1
	THICK2 (106-140g/m <sup>2</sup> )	ST-R(5.5"X8.5"), COMP(10•1/8"X14")	20 sheets	
	THICK3 (141-209g/m <sup>2</sup> )			
	Labels (THICK2,THICK3)	(Non-standard size) Length:100-305mm, Width:148-457mm		*1
	OHP film	(Standard size) A4	20 sheets	Paper cannot be placed in the A4-R direction. *1
	Plain paper	(Standard size) A4	1500sheets(80,90g/m <sup>2</sup> ) 1250sheets(105g/m <sup>2</sup> )	Paper cannot be placed in the A4-R direction.

\*1...Duplex copying with the optional automatic duplexer is not available.

## Recommended Paper

To make copies with a fine image, use of the following sheets is recommended.  
If you use copy paper other than the recommended types, ask your service technician.

Paper Type	Toshiba Recommendations / Manufacturer	Size	Mode
Plain Paper	Color Copy (90g/m <sup>2</sup> ) / Neusiedler	A3, A4	PLAIN
Thick Paper	Color Copy (100g/m <sup>2</sup> ) / Neusiedler	A3, A4	THICK 1
	Color Copy (120g/m <sup>2</sup> ) / Neusiedler	A3, A4	THICK 2
	Color Copy (160g/m <sup>2</sup> ) / Neusiedler	A3, A4	THICK 3
	Color Copy (200g/m <sup>2</sup> ) / Neusiedler	A3, A4	THICK 3
Labels	5165 / Zweckfoem-Avery	A4	THICK 2
OHP Film	CG 3700 / 3M BG 78 / Folex	A4 (125µm)	OHP FILM

\* Be sure to use only the OHP films specified by Toshiba.

Using other types of OHP films may result in the failure of the copier.

### Instructions before use

- Using paper with a special process on the surface, paper printed by another copier, or making a copy on the paper surface that has already been copied once may cause poor copy quality.
- Do not use creased, folded, wrinkled, curled, slippery or stiff paper which may cause paper jams.
- Keep the copy paper wrapped. Do not expose it to high humidity after taking the copy paper out of the wrapping paper.

## 2. ENERGY-SAVING FUNCTION

The energy-saving function is to save the power consumption by lowering the fuser temperature while the copier is not being used.  
There are two levels for this function.

	Energy saving efficiency	Warm-up time
Level 1	approx.50% (142W)	approx.5 minutes
Level 2	approx.20% (227W)	approx.2 min.30 sec.

- \* Power consumption during normal standby : approx. 284W
- Level 1 is set as the default mode. You can switch the initial mode depending on user's environment (see page 119).

### Forcibly Switching to Energy-saving Mode

Press the **ENERGY SAVER** key on the control panel to forcibly switch to the energy-saving mode (see page 10).

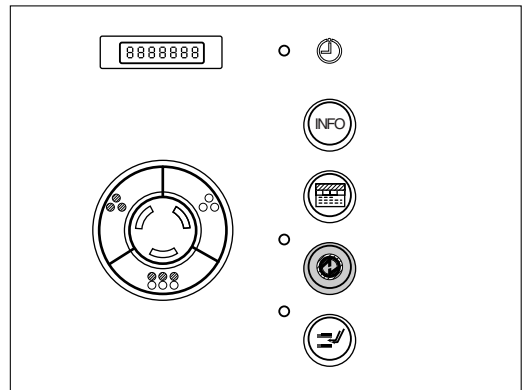

### Cancelling the Energy-saving Mode

Press the **ENERGY SAVER** or **START** key on the control panel.

The Energy-saving lamp goes off and the copier starts warming up again (see page 10).  
See the table above for the warm-up time.



# 3. TURNING ON THE POWER SWITCH / AUTO JOB START

## Turning ON the Power Switch

- 1 Turn ON the power switch.

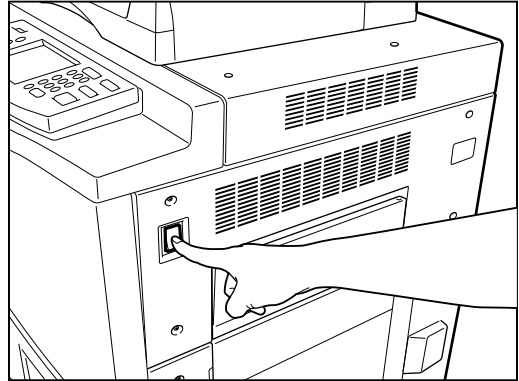

- The following message appears.

Wait Warming Up

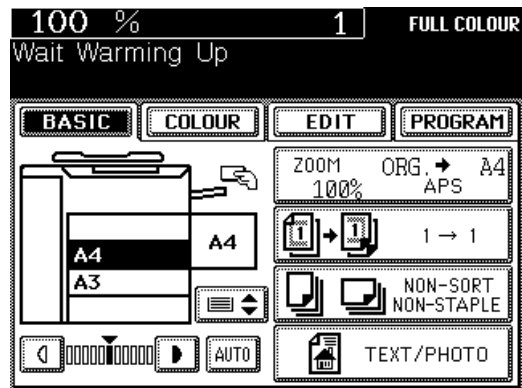

- 2 About 9 minutes later, the message "READY" appears.

- This message indicates that you can make copies at any time.

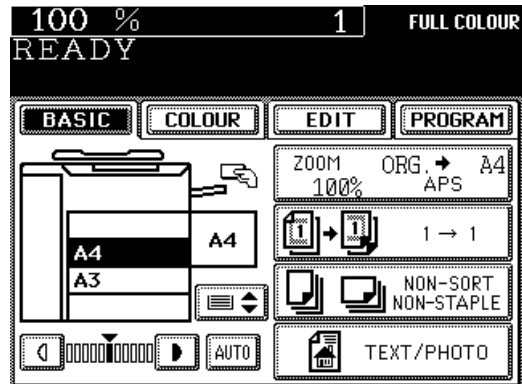

- **If this message appears:**

If the copier has not been used for a long time, the copier automatically goes into the adjustment mode and the message on the right appears before warming up. It will soon start working. Do not turn OFF the power. Just wait for a while.

Wait  
Performing Auto Calibration

HOW TO  
MAKE  
COPIES

# 3. TURNING ON THE POWER SWITCH / AUTO JOB START (Cont.)

## Auto Job Start

If you set the desired copying modes and press the START key during warm-up, the copier automatically starts copying when it becomes READY.

### 1 Place the original(s) on the original feed tray or on the glass.

#### When Using the Automatic Document Feeder

- After aligning the edges of the originals, set them face up on the original feed tray and align the slides to the edges of the originals.
- See page 24 for the number of the originals you can set up at a time.

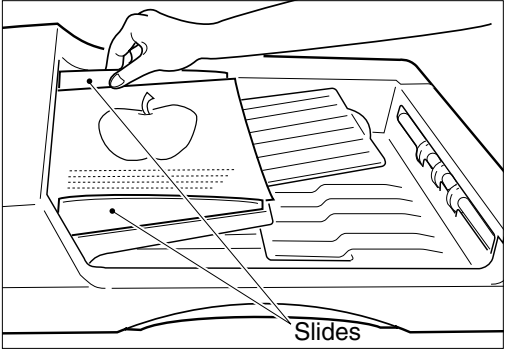

**Note:** Remove any paper clips or staples from originals before placing them on the original feed tray.

#### When Placing the Original on the Glass

- Lifting the original cover or the reversing automatic document feeder, place the original on the glass face down and with its bottom toward you and with its top left aligned against the original scale on the left side.
- Close the original cover or the reversing automatic document feeder slowly after the original size has been detected.

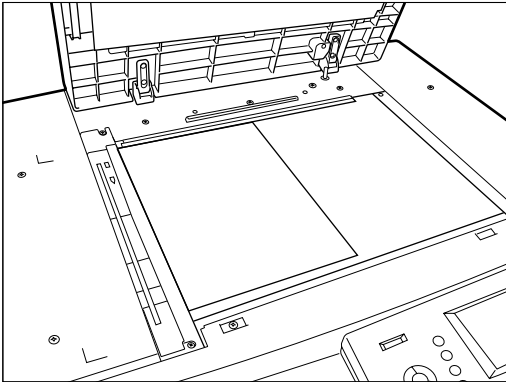

### 2 Set the desired copy modes.

- The automatic paper selection (APS) mode and copying of one original are selected as the default modes, but the original size is not automatically detected in the auto job start mode.

### 3 Press the START key.

- The message “Wait Warming Up. Auto Start” appears. When the copier becomes ready, it automatically starts copying in the selected modes.

**Tip:** You can change the copying modes even after pressing the START key. To cancel the Auto Job Start mode, press the CLEAR key or the FUNCTION CLEAR key.

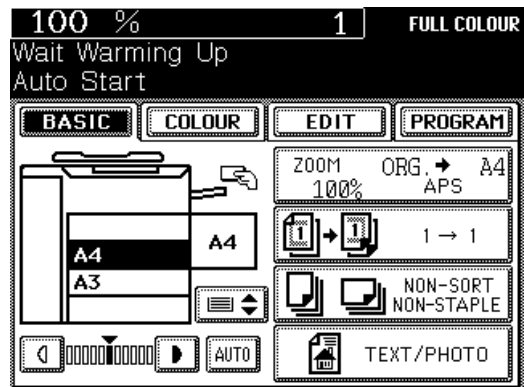
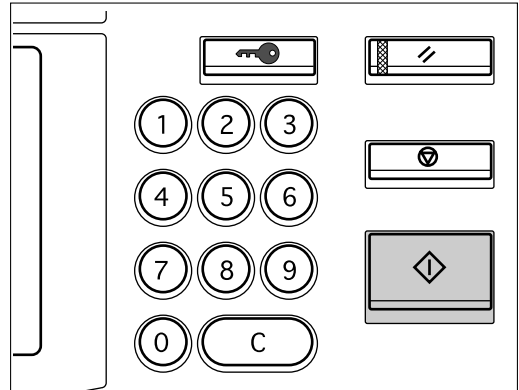

# 4. USING THE REVERSING AUTOMATIC DOCUMENT FEEDER (OPTIONAL)

The optional Reversing Automatic Document Feeder automatically feeds and copies sheet paper originals placed on the feeding tray one at a time. This is called the "continuous feed mode." You can also manually feed originals in one sheet at a time. This is called the "single feed mode." If you feed in two-sided originals, this document feeder automatically reverses originals after they have been copied so that their reverse sides can be copied.

## Precautions When Feeding Originals

**1** Use originals with a paper weight in the range of 60 to 105 g/m<sup>2</sup>.

**2** The number of the originals you can set up at a time differs depending on their size.

	60~90g/m <sup>2</sup>	91~105g/m <sup>2</sup>
A4, A4-R, A5-R	50	40
FOLIO	35	25
A3	25	20

**3** Do not use the following types of originals as they tend to misfeed or become damaged in the reversing automatic document feeder:

(1) Badly wrinkled or folded originals. In particular, originals whose leading edge is curled may be misfed.



(2) Carbon paper



(3) Taped originals

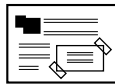

(4) Clipped or stapled originals



(5) Torn originals (including those with holes in them)



(6) Damp originals



(7) OHP film originals

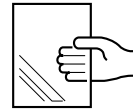

**4** Folded or curled originals should be smoothed out before being set on the reversing automatic document feeder.

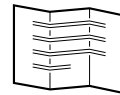

**5** Do not mix originals of different widths at the same time.



**6** If the surface of the originals is so rough that they cannot be moved when two of them are pinched between two fingertips, or if the surface has been processed, these originals could not be used because the automatic document feeder may not be able to separate them.



## Copying in the Continuous Feed Mode

**1** Press the **PROGRAM** key on the display panel.

**2** Press the **ADF** key.

**3** Press the **ADF** key on the panel to select continuous feed.

- **ADF** is highlighted and selected as the default feed mode.
- The panel returns to the original display.

**4** Select the desired copy size, reproduction ratio, image density level and copy quantity.

- The automatic paper selection mode is selected as the default mode.

**5** Place the originals on the original feed tray.

- After aligning the edges of the originals, set them face up on the original feed tray and align the slides to the edges of the originals.

- For setting A3 or B4 sized paper, pull out the paper holder in the direction of the arrow.

**6** Press the **START** key.

- The originals are fed starting with the lowermost one.

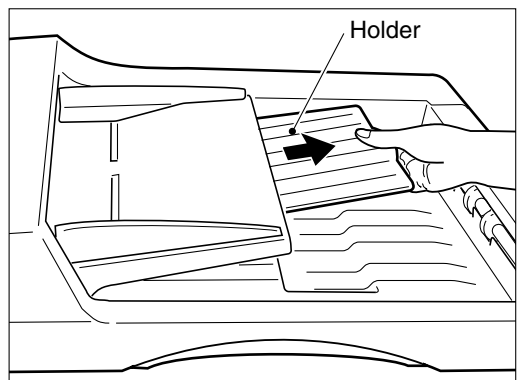
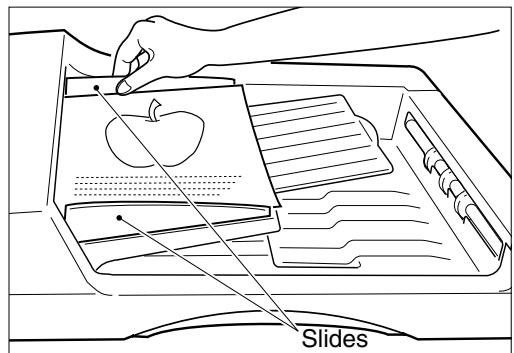
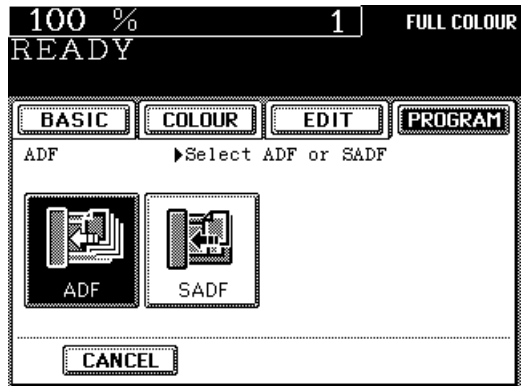
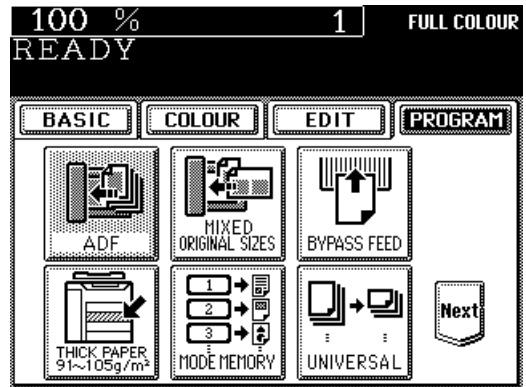

# 4. USING THE REVERSING AUTOMATIC DOCUMENT FEEDER (OPTIONAL) (Cont.)

## Copying in the Single-Feed Mode

**1** Press the **PROGRAM** key on the display panel.

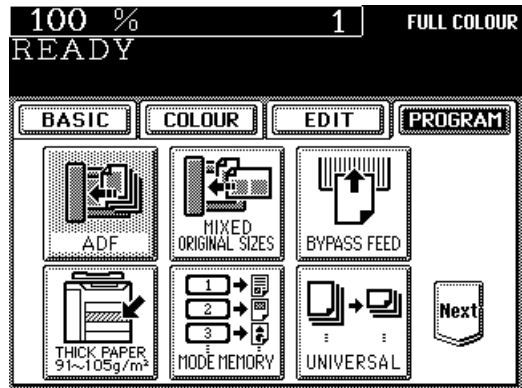

**2** Press the **ADF** key.

**3** Press the **SADF** key on the panel to select single feeding.

- **SADF** is highlighted and selected.
- The touch panel returns to the original display.

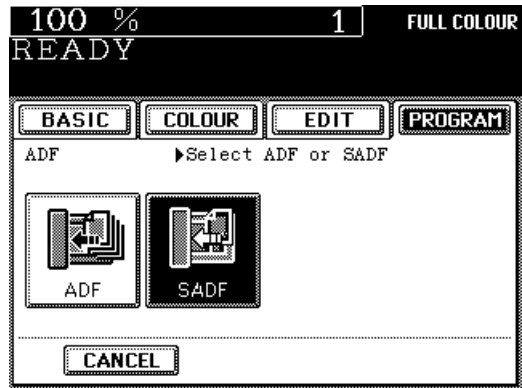

**4** Select the desired copy size, reproduction ratio, image density level and copy quantity.

- The automatic paper selection mode is selected as the default mode.

**5** Align the slides on the original feed tray to the size of the original.

- Set the slides a little wider than the actual original width.

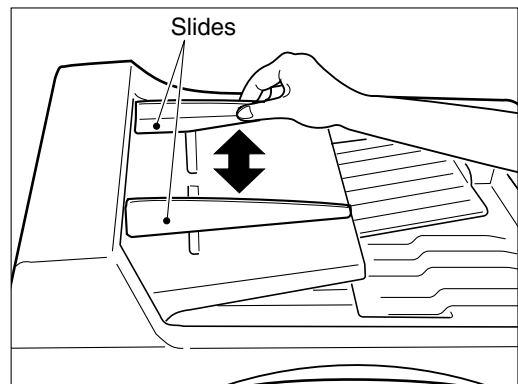

**6** Insert the original.

- Place the original face up and insert it in straight along the slides.
- When the original starts being pulled in automatically, let go of the original. The original is automatically copied.

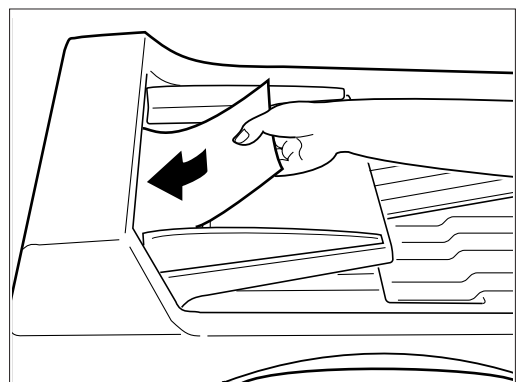

## Copying in the Mixed Originals Mode

1 Press the **PROGRAM** key on the display panel.

2 Press the **MIXED ORIGINAL SIZES** key.

3 As explained on the screen on the right below, place the originals on the original feed tray.

- Mixed originals of A3 and A4 sized paper can be copied at the same time.
- After aligning the edges of the originals, set them face up on the original feed tray and align the slides to the edges of the originals.
- The number of the originals you can load at a time is 25.

4 Press the **SET** key .

5 Select the Automatic Paper Selection (APS) mode or Automatic Magnification Selection (AMS) mode. Then select the desired copy size, reproduction ratio, image density level and copy quantity as required.

- To make duplexed copies, select the Automatic Magnification Selection (AMS) mode.

6 Press the **START** key.

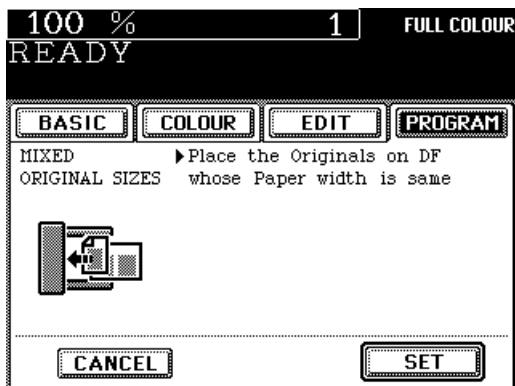
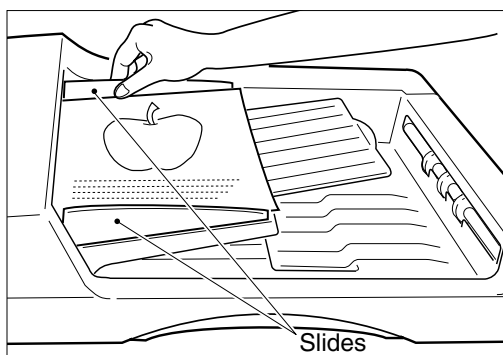
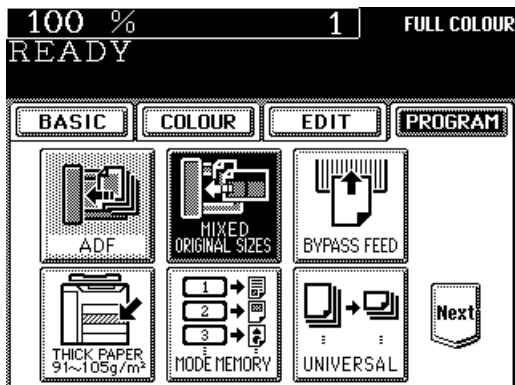

# 5. COPYING IN THE AUTOMATIC PAPER SELECTION MODE

When the power switch is turned ON, the Automatic Paper Selection (APS) mode is selected as the default mode.

In this mode, if you place an original on the document feeder or on the glass, the copier automatically detects the size of the original, and selects paper of the same size as the original. This mode is available only for actual-size (100%) copying.

## Procedure

### 1 Check that the Automatic Paper Selection mode is selected.

- If **APS** is not indicated, press the **ZOOM** **ORG.→A4** key and select **APS**.

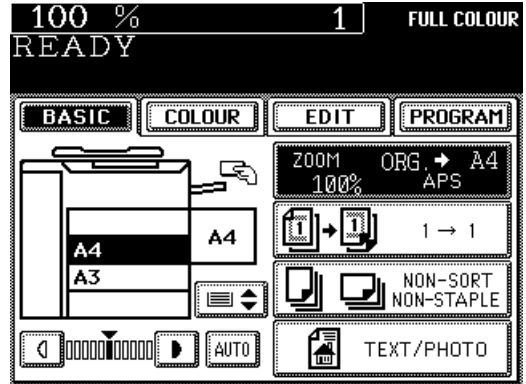

### 2 Place the original(s) on the original feed tray or on the glass.

#### When Using the Reversing Automatic Document Feeder

- After aligning the edges of the originals, set them **face up** on the original feed tray and align the slides to the edges of the originals.
- See page 24 for the number of the originals you can set up at a time.
- When the **START** key is pressed, the sensor detects the size of the first original, and selects the paper size matched to the original.

**Note:** Remove any paper clips or staples from the originals before placing them on the original feed tray.

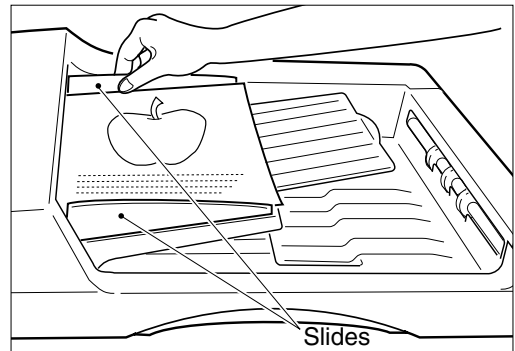



### When Placing the Original on the Glass

- Lifting the original cover or the optional reversing automatic document feeder, place the original on the glass **face down** and with its bottom toward you and with its top left aligned against the original scale on the left side.
- The sensor unit immediately detects the size of the original, and selects the paper size matched to the original.
- Close the original cover or the reversing automatic document feeder slowly after the original size has been detected.
- Sometimes the following message appears:

Change direction of original



Change the direction of the original on the glass.

Or

Set correct cassette

Install the correct-sized cassette.

### 3 Select the image density level.

- The MANUAL COPY DENSITY mode is selected as the default mode.
- If you want to select the desired image density, press the  or  key.
- If the AUTOMATIC COPY DENSITY **AUTO** is selected, the optimum image density is automatically provided according to the darkness of the original.

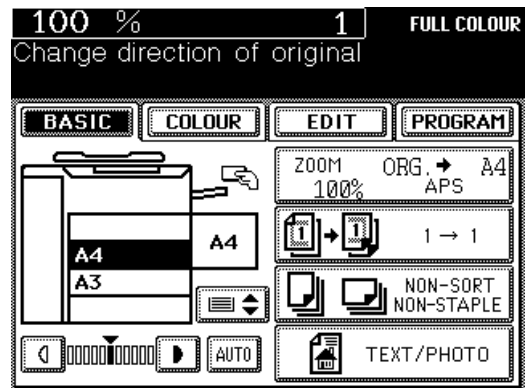
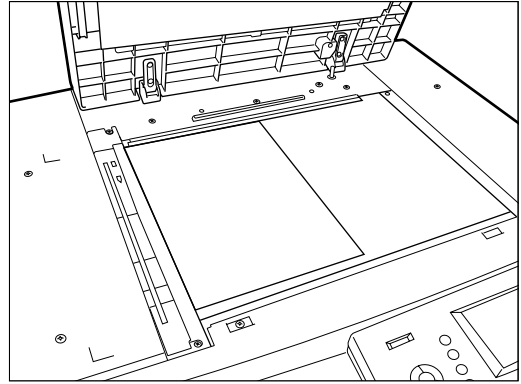

## 5. COPYING IN THE AUTOMATIC PAPER SELECTION MODE (Cont.)

4

### Key in the desired copy quantity.

- You can key in up to 999.
- There is no need for this when making only one copy.
- When an incorrect quantity is set, press the CLEAR key and key in the correct number.
- If you press the FUNCTION CLEAR key, all items that you have set are cleared, and the copier returns to the default mode and the Basic menu appears.

5

### Press the START key.

- Copying starts and when the required number of copies are made, the copier automatically stops.
- If you do not press the START key within 45 seconds after having set the desired copy modes, the functions you have selected are automatically cleared to the default mode.

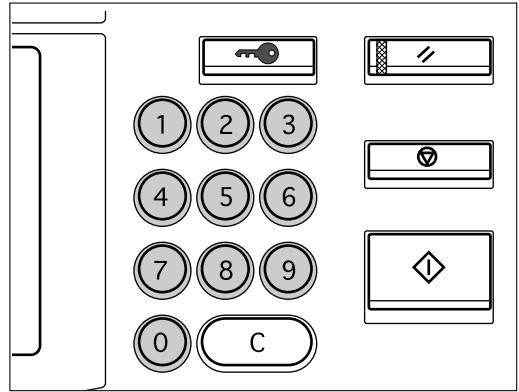

## When the Automatic Paper Selection is not Available

The copier may not be able to detect the size of the following types of original in the APS mode:

- Transparent originals such as OHP film
- Entirely blackish originals or originals with blackish edges
- Non-standard size originals such as newspapers and magazines.

Select the copy size referring to the following steps.

### 1 Place the original(s) on the original feed tray or on the glass.

- See page 22 for how to set the originals.

### 2 Select the desired paper size.

- Press the cassette of the desired copy size on the Basic menu.

- Or press the **ZOOM ORG.→A4** key on the Basic menu to display the screen on the right, then press the key of the desired copy size.

### 3 Return to the Basic menu, then select the image density level and copy quantity as required.

### 4 Press the START key.

**Tip:** If there are sheets of paper set on the sheet bypass, you must press the COPY-SIZE key corresponding to the sheets. See page 41.

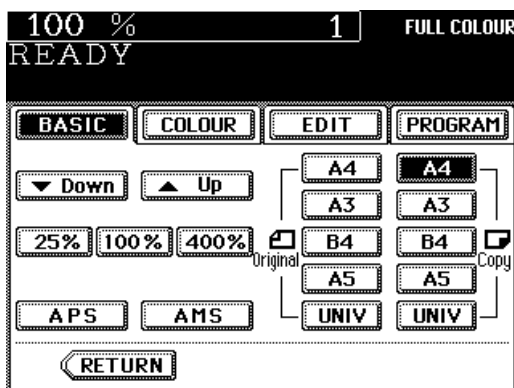
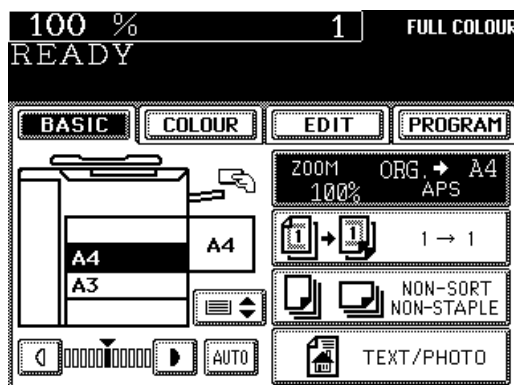

# 6. REDUCTION AND ENLARGEMENT COPYING

There are three methods available for enlargement and reduction copying.

- Using Automatic Magnification Selection (AMS):  
After selecting the AMS mode and the copy size, when you place an original on the glass or when an original is fed from the reversing automatic document feeder, the copier automatically detects the size of the original, and calculates the appropriate reproduction ratio.
- Specifying the original and copy sizes:  
When you specify both the original and copy sizes, the copier automatically calculates the appropriate reproduction ratio.
- Using the ZOOM keys:  
The ZOOM keys **▼ DOWN** and **▲ UP** allow selection of the desired reproduction ratio from the range of 25% to 400% at increments by 1%.  
\* See page 82 for X-Y zoom.

## Using Automatic Magnification Selection

**1** Press the **ZOOM ORG. → A4** KEY.

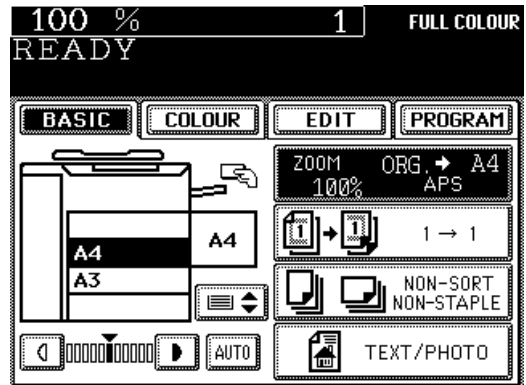

**2** Press the **AMS** key.

- The **AMS** key gets highlighted.

**3** Press the desired **COPY-SIZE** key.

- The selected COPY-SIZE key gets highlighted.

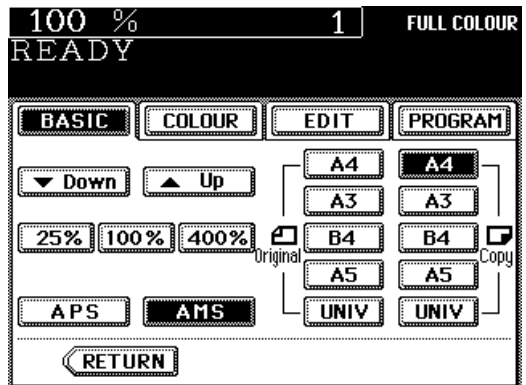

**4** Place the original(s) on the original feed tray or on the glass.

- See page 22 for how to set the originals.

- The sensor unit immediately detects the size of the original, selects the paper size matched to the original, and calculates the reproduction ratio based on the detected original size and the selected copy size. The reproduction ratio is then displayed.

- If the following message appears:

Change direction of original  
 , change the direction of the original on the glass.

- If the following message appears:

Use reduction cassette  
 , install the correct-sized cassette, and start the procedure all over again.

## 5 Select the desired image density level and copy quantity.

## 6 Press the START key.

- Reduced or enlarged copies of the selected size will exit.

### Tips:

The copier may not be able to detect the following types of original in the AMS mode:

- Transparent originals such as OHP film
- Entirely blackish originals or originals with blackish edges

Refer to "Selecting the Original Size and the Copy Size" on page 34 to make copies of such originals.

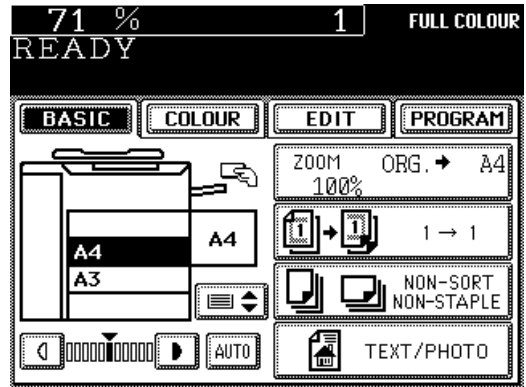

# 6. REDUCTION AND ENLARGEMENT COPYING (Cont.)

## Selecting the Original Size and the Copy Size

**1** Press the **ZOOM ORG. → A4** KEY.

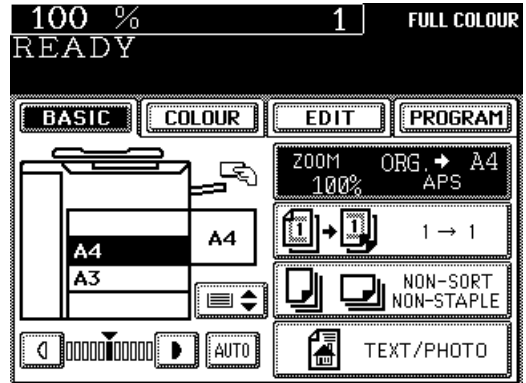

**2** Press the **ORIGINAL SIZE** key of the same size as the original to be copied.

**3** Press the desired **COPY-SIZE** key.

- The copier calculates the correct reproduction ratio based on the selected original size and copy size, and displays the reproduction ratio on the reproduction-ratio display. (See page 103 for how to use the **UNIV** key.)

- If the desired size of paper is not in any of the installed cassettes, the following message appears:

Set correct cassette

Install the correct-sized cassette or use the sheet bypass.

**4** Place the original(s) on the original feed tray or on the glass.

- See page 22 for how to set the originals.

**5** Select the desired image density level and copy quantity.

**6** Press the **START** key.

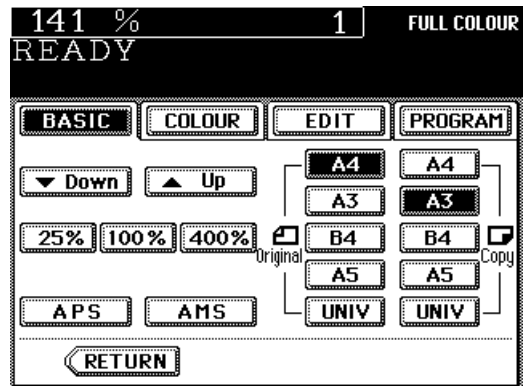

**Tip:** If there are sheets of paper set on the sheet bypass, you must press the COPY-SIZE key corresponding to the sheets (see page 41).

## Using the Zoom Keys

**1** Press the desired cassette on the display panel.

**2** Press the **ZOOM ORG. → A4** KEY.

**3** Press the **▲ Up** or **▼ Down** key to select the desired reproduction ratio.

- For enlargement, use the **▲ UP** key. For reduction, use the **▼ DOWN** key.
- Each time you press either ZOOM key, the reproduction ratio changes by 1%. Holding down the key changes the reproduction ratio continuously.
- Pressing the **400%** key or the **25%** key causes 400% or 25% to be immediately displayed.
- Pressing the **100%** key returns the copier to actual-size copying.

**4** Select the desired image density level and copy quantity if required.

**5** Press the **START** key.

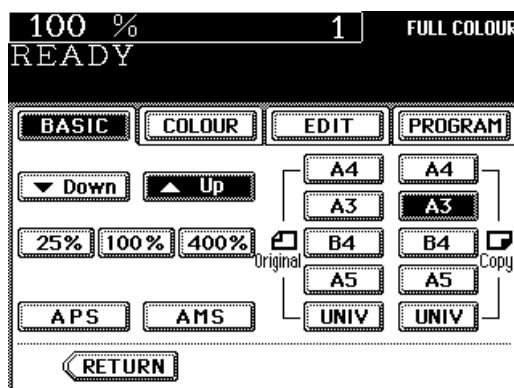
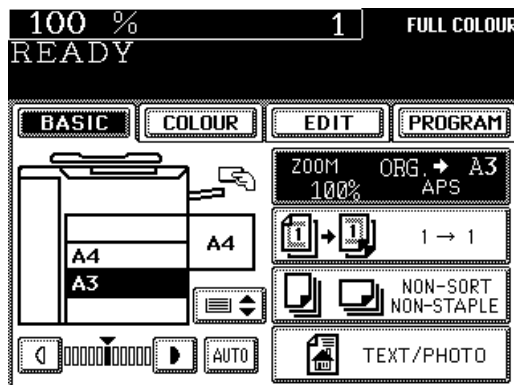





# 7. COPYING WITH COPY DENSITY SELECTION

There are two modes of adjusting the image density and background level of the copy. In the manual copy density mode, you can produce lighter or darker copies. In the automatic copy density mode, the copier automatically detects the density of the original, and selects the optimum image density and background level. This mode is suitable for originals containing only text and illustrations. Originals with black areas and halftoned originals should be copied in the manual copy density mode.

## Copying in Manual Density Mode

### 1 Press the or key to change the copy density.

- To produce lighter copies, press the  key. Each time you press the  key, the density-indicating mark moves one step to the left, and your copies are produced proportionally lighter.
- To produce darker copies, press the  key. Each time you press the  key, the density-indicating mark moves one step to the right, and your copies are produced proportionally darker.

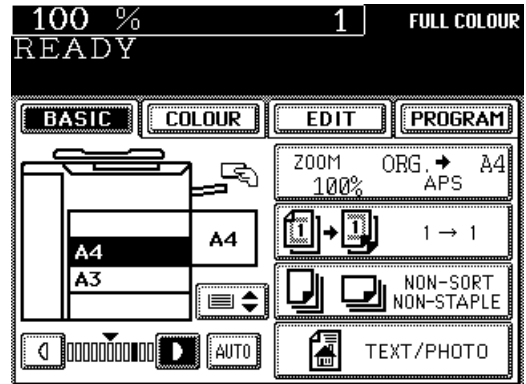

### 2 Place the original(s) on the original feed tray or on the glass.

- See page 22 for how to set the originals.

### 3 Set the desired copy size, reproduction ratio and copy quantity if required.

### 4 Press the START key.

- Copies are made in the selected copy density level.



## Copying in Automatic Density Mode

- 1 Press the **AUTO** key.
- 2 Place the original(s) on the original feed tray or on the glass.
  - See page 22 for how to set the originals.
- 3 Set the desired copy size, reproduction ratio and copy quantity if required.
- 4 Press the **START** key.
  - The copier automatically detects the density of the original, and makes copies at the optimum image density and background level.

### Tips:

- When copying has been completed, the **FUNCTION CLEAR** key flashes. Press it or press nothing for 45 seconds to clear the automatic copy density mode to the default mode (manual copy density).
- In the automatic copy density mode, the background level is detected during copying, so the copying speed becomes slower.

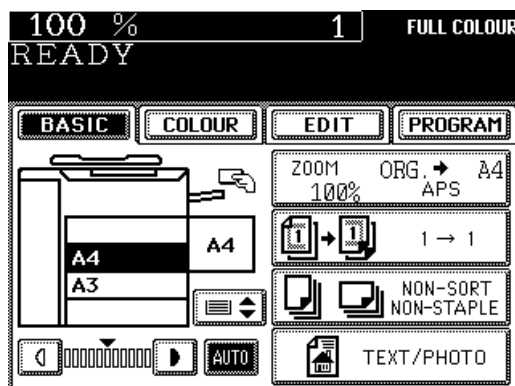

# 8. COPYING BY ORIGINAL MODE SELECTION

You can select the copy mode (Text/Photo, Text, Printed Image, Photo, Map or Advanced Image) and produce clear copies matched to the type of original.

\* Advance Image Enhancement mode is an optional.

\* The advance image enhancement mode requires the optional AI board to be installed.

## 1 Place the original(s) on the original feed tray or on the glass.

- See page 22 for how to set the originals.

## 2 Press the **TEXT/PHOTO** key on the Basic menu.

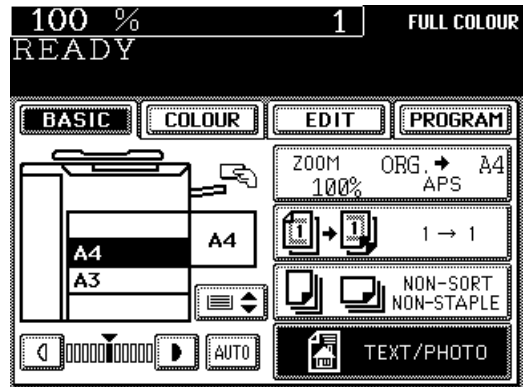

## 3 Press the **TEXT/PHOTO**, **TEXT**, **PRINTED IMAGE**, **PHOTO**, **MAP** or **ADVANCED IMAGE** key.

- The screen on the right is displayed.

Select the appropriate mode depending on the type of original.

**Text/Photo**: Original with text and photo mixed together

**Text**: Original with text only (or text and line artwork)

**Printed Image**: Original with printed photos such as gravure photos of a magazine

**Photo**: Original with photos printed on photographic paper

**Map**: Original with fine illustrations and text



**Advanced Image** (Optional) :

The copier automatically recognizes the contents of the original in each block or originals in each page and makes copies in appropriate modes.

This is suitable for copying several types of originals mixed together.

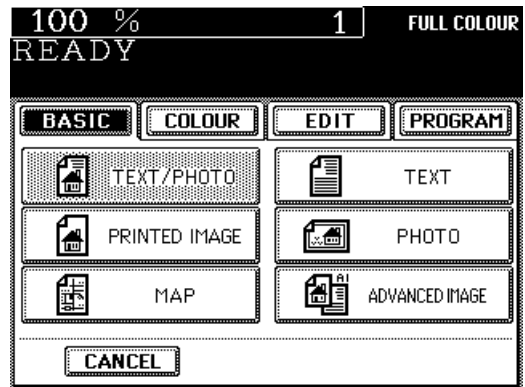
**Note:** In the Advance Image Enhancement mode, the patterns of originals are recognized during copying, so the copying speed becomes slower.



**4** If necessary, press the  or  key to adjust the image density.

**5** Select the desired copy size, reproduction ratio and copy quantity.

**6** Press the **START** key.

- Copies are made in the selected copy mode.

# 9. COLOUR MODE

This function is to switch the colour copy mode and black-and-white copy mode.

## Selecting the Colour Mode

### 1 Press the desired colour mode selection key.

- **FULL COLOUR**: Regardless of colour, all originals are colour-copied.
- **AUTO COLOUR**: The type of original is automatically recognized. Coloured originals are colour-copied and black-and-white originals are copied in black-and-white.
- **BLACK**: Regardless of colour, all originals are copied in black.

**Note:** Full colour mode is selected as the default mode.

See page 119 for changing the initial mode.

- The lamp of the selected key is highlighted and the selected colour mode is displayed in the top right corner of the display panel.

#### Tips:

- In the AUTO COLOUR mode, the colours of originals are recognized during copying, so the copying speed becomes slower.
- In the AUTO COLOUR mode, if the colour area is too small or the colours are close to black or they are too light, colour originals may be copied in black. In this case, select the FULL COLOUR mode.
- Yellowish originals or originals with a coloured background may be automatically copied in colour even though they are black-and-white. To be certain to make the copies in the desired mode, select FULL COLOUR or BLACK.

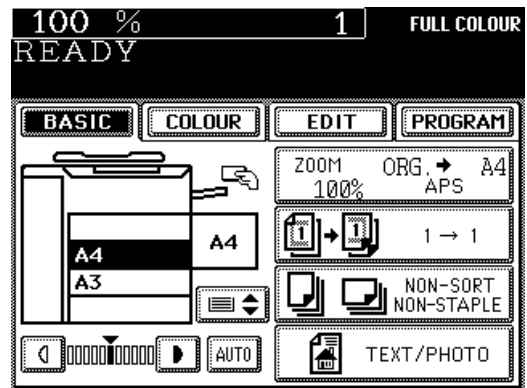
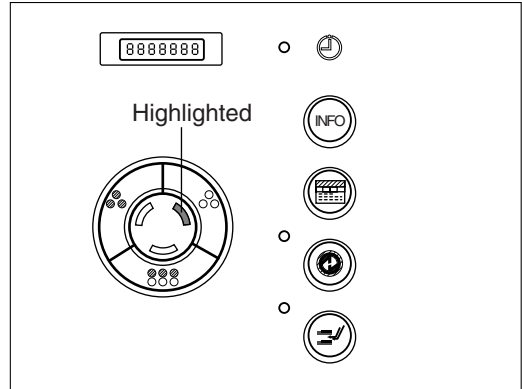

# 10. BYPASS COPYING (THICK PAPER/OHP FILM)

Bypass copying is convenient when the size of any paper cassettes installed in the copier is not the size you require or when you want to use special sizes of paper such as A3-wide (305X457mm) paper or special types of paper such as thick paper and OHP films(transparency or sticker labels).

## Bypass Copy Mode

- This copier has bypass copy modes corresponding to paper types. Refer to the table below and select the mode corresponding to the sheets. Otherwise, it may cause paper jams or lower the image quality.
- The number of sheets that can be set at a time differs depending on paper type. Setting more than specified number of sheets at a time may cause copier failure or paper jams. Be sure to set within the specified range.
- The range of acceptable paper sizes is from A3-wide to A5-R.

HOW TO  
MAKE  
COPIES

Bypass Copy Mode	Corresponding Paper Type	Maximum Capacity
PLAIN	Plain paper (64-80g/m <sup>2</sup> )	approx.50 sheets
	Plain paper (81-90g/m <sup>2</sup> )	approx.40 sheets
305X457mm	*A3-wide (64-105g/m <sup>2</sup> )	approx.30 sheets
OHP FILM	OHP films	approx.20 sheets
THICK 1	Thick paper (91-105g/m <sup>2</sup> ) (excluding A3-wide)	approx.30 sheets
THICK 2	Thick paper (106-140g/m <sup>2</sup> )	approx.20 sheets
THICK 3	Thick paper (141-209g/m <sup>2</sup> )	
	Thick sticker labels	

\*A3-wide paper = 304.8mmX457.2mm

# 10. BYPASS COPYING (THICK PAPER/OHP FILM) (Cont.)

## Procedure

**1** Place the original(s) on the original feed tray or on the glass.

- See page 22 for how to set the originals.

**2** Place the sheets of copy paper on the sheet bypass and align the slides to the paper size.

- If you put several sheets on the sheet bypass at a time, fan the paper well before placing it.

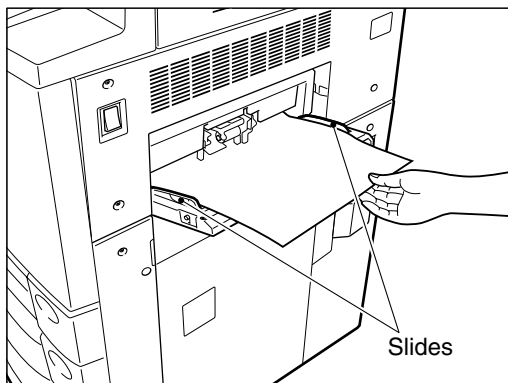

- For setting horizontally long-sized paper such as A3, B4 or A4-R sized paper, pull out the paper holder.

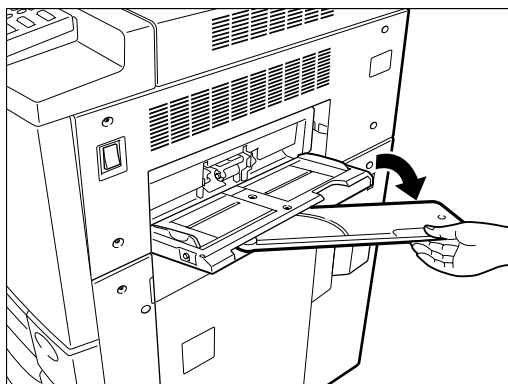

**3** Press the **PROGRAM** key to enter the Program menu, then press the **BYPASS FEED** key.

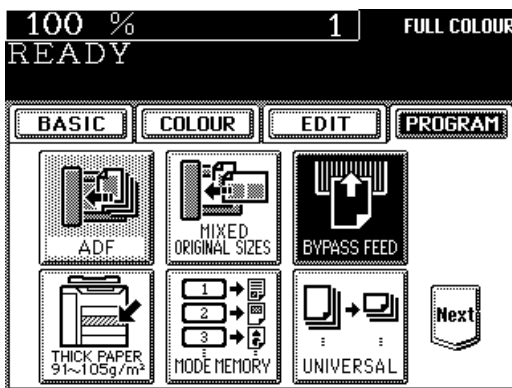

- When paper is not set on the sheet bypass, the display in step 4 also appears if you select bypass copying by pressing the bypass guide icon  on the screen on the right.

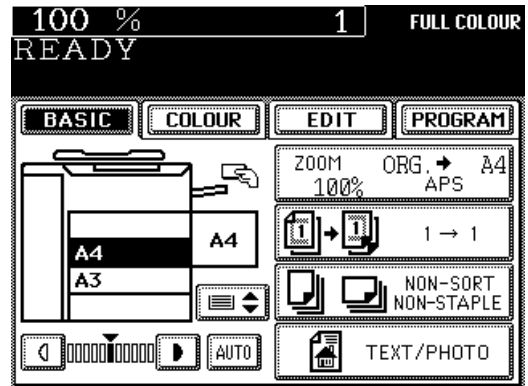

## 4 Select the desired paper type.

- Plain paper is selected as the default mode.

### Plain Paper

Press the **PLAIN** key, then the **SET** key.

### A3-wide(305X457mm)

Select the paper thickness among **PLAIN**, **THICK1**, **THICK2** and **THICK3** keys, press the **305X457mm** key, then the **SET** key.

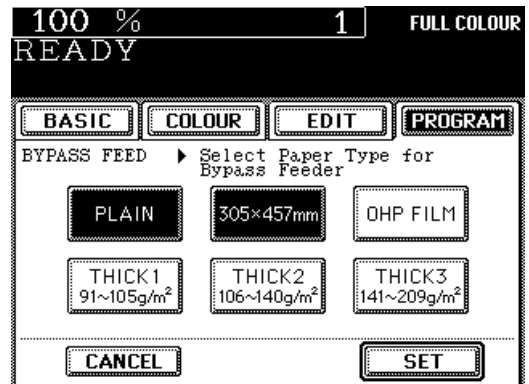

## 5 Select the desired copy size and set the other copy modes if required.

### Tips:

- If A4-R paper is used, press the **A4** key twice.
- If the size of the sheets fed from the sheet bypass is not set, the Automatic Magnification Selection is cancelled.

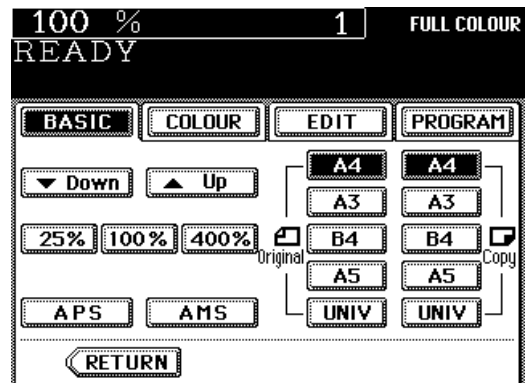

## 6 Set the copy quantity.

# 10. BYPASS COPYING (THICK PAPER/OHP FILM) (Cont.)

**7** Press the **START** key.

**Tips:**

- If the **BYPASS MISFEED** symbol flashes, pull out the paper and set it on sheet bypass again.
- When copying is finished, the lamp of the **FUNCTION CLEAR** key lights. Press the **FUNCTION CLEAR** key, or the bypass copying mode will automatically return to the default mode in 45 seconds.

## Thick Paper

- Use the recommended thick paper and sticker labels if possible. Thick paper sold at stores is also available for this copier, but paper of some brands may not be suitable to acquire a clear image. In this case, ask your service technician.
- It takes about 30 seconds to a few minutes to switch between "PLAIN" X "A3-wide (305X457mm)" X "OHP FILM" and "THICK1" X "THICK2" X "THICK3" for adjustment.

**1** Perform step 1 to 3 on page 42.

**2** Check the type of the thick paper and press the **THICK1**, **THICK2** or **THICK3** key.

**Tip:** For bypass copying mode for thick paper and sticker labels, see the table on page 41.

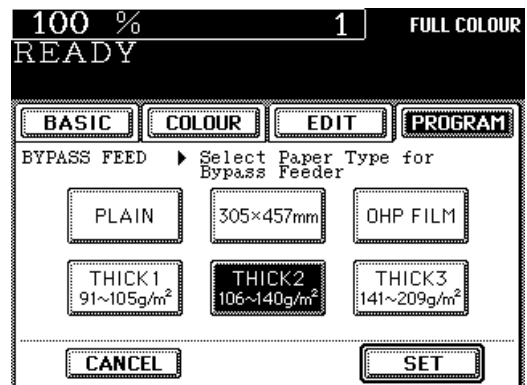



### 3 Select the copy size for bypass copying and set the desired reproduction ratio if required (see page 32).

- Press the COPY-SIZE key corresponding to the copy paper that is set.
- If A4-R paper is used, press the **A4** key twice.

**Tip:** If the size of the sheets fed from the sheet bypass is not set, Automatic Magnification Selection is cancelled.

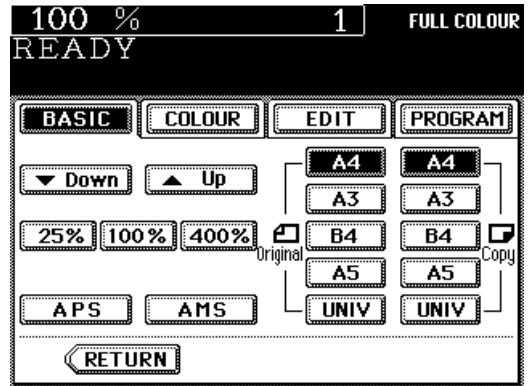

### 4 Set the copy quantity.

### 5 Press the START key.

# 10. BYPASS COPYING (THICK PAPER/OHP FILM) (Cont.)

## OHP Films

- Use the recommended OHP films (A4 only). Using other kinds of OHP films may cause jams and copier failure, and image quality may be lowered as well and copies cannot be made in clear colour. If you want to use the other kinds of OHP films, ask your service technician.
- Set the OHP films on the sheet bypass vertically (same as A4 placement). If you set them horizontally (same as A4-R placement), the following message will appear:

Set transparency film in A4 direction

- If you select the OHP Film mode, the copy speed becomes slower.

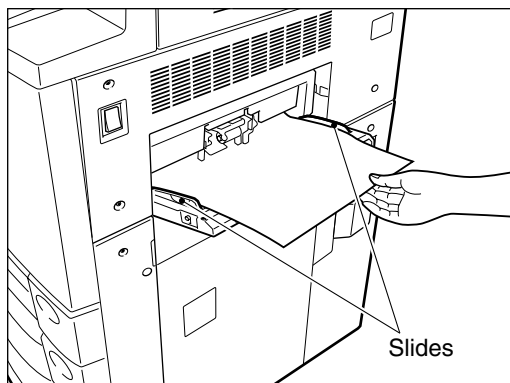

**1** Perform step 1 to 3 on page 42.

**2** Press the **OHP FILM** key.

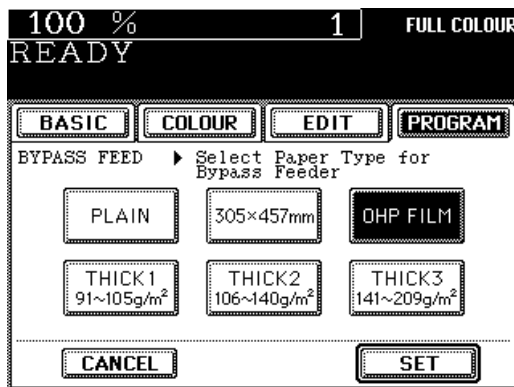

**3** A4 is automatically selected for the copy size.

**4** Set the copy quantity.  
**Tip:** Up to 20 OHP films can be set at a time. If you will make copies of more than 20 films, feed them from the exclusive cassette for OHP (see page 48).

**5** Press the **START** key.

# 11. CASSETTE SETTING FOR THICK PAPER/OHP FILM

Thick paper with a weight of 91~105g/m<sup>2</sup> can be fed from the cassette or large-capacity feeder, and OHP film can be fed from the cassette. This is convenient if copies are often made on special paper.

## Setting the Cassette for Thick Paper (91~105g/m<sup>2</sup>)

**1** Set the thick paper (91~105g/m<sup>2</sup>) on the 2<sup>nd</sup>, 3<sup>rd</sup> or 4<sup>th</sup> cassette, or the large-capacity feeder.

- The procedure for changing the paper size of the cassette for thick paper is the same as that for normal paper. See page 130.
- Thick paper with a weight of greater than 105g/m<sup>2</sup> can be fed only from the sheet bypass. See page 42.
- Up to 400 sheets (105g/m<sup>2</sup>) can be set at a time.
- Duplex copying with the optional automatic duplexer is not available.

**2** Press the **PROGRAM** key to enter the Program menu, and press the **THICK PAPER** key.

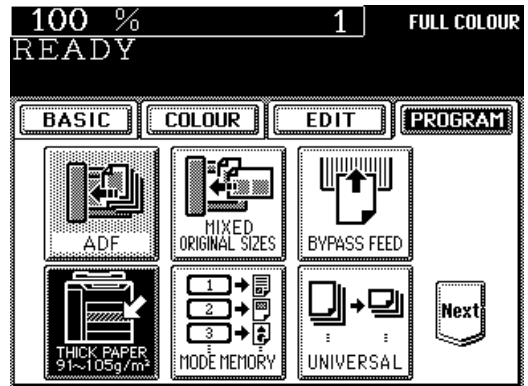

**3** Press the cassette you have set the thick paper on the display.

- The top cassette cannot be set for thick paper. Use the 2<sup>nd</sup>, 3<sup>rd</sup> or 4<sup>th</sup> cassette, or the large-capacity feeder.

**4** Press the **SET** key.

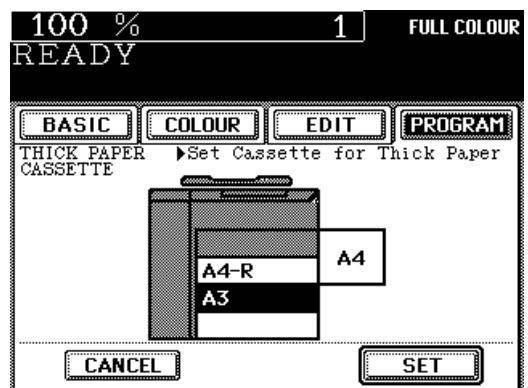

# 11. CASSETTE SETTING FOR THICK PAPER/OHP FILM (Cont.)

- 5** Check that THICK 1 is shown on the selected cassette of the display.

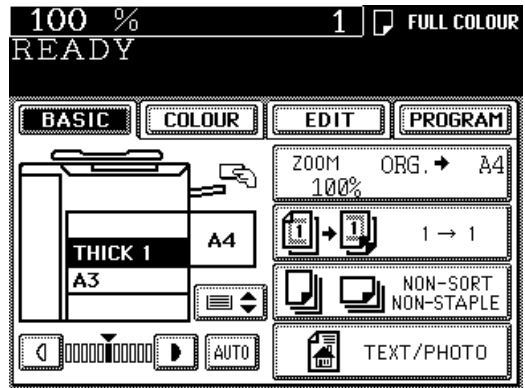

## Setting the Cassette for OHP Film

- 1** Pull out the second cassette slowly until comes to a stop.
- Only the 2nd cassette is available for setting the cassette for OHP films.

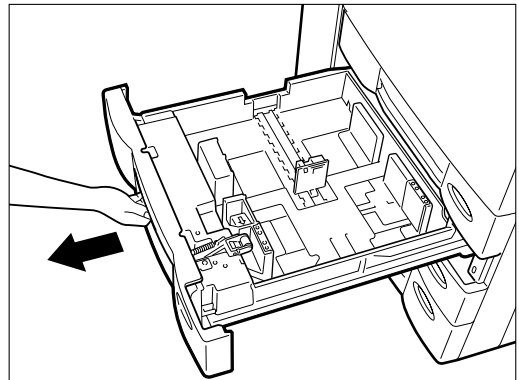

- 2** Set the OHP films on the cassette.
- Acceptable size is A4 only. Be sure to set them vertically (same as A4 placement).
  - Up to 100 films can be set at a time.

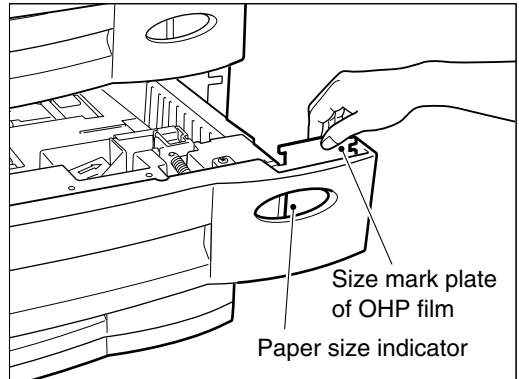

- 3** Take out the size mark plate of the cassette and set that of the OHP film.
- "OHP FILM" is shown in the paper size indicator.

- 4** "OHP FILM" is displayed on the second cassette on the Basic menu.

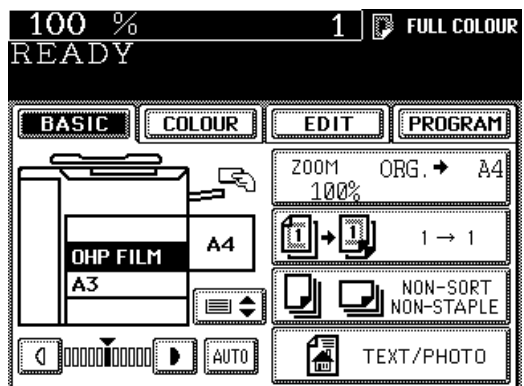

# 12. INTERRUPT COPYING

The interrupt copying mode is convenient when you want to make copies of another set of originals during a multicopy run. Interrupt copying is possible using the cassettes or the bypass.

## 1 Press the INTERRUPT key.

The following message appears:

Job interrupted job 1 saved

## 2 Replace the original with a new original.

- See page 22 for how to set the original.

**Tip:** During the interruption, the reversing automatic document feeder (optional) and automatic duplexer (optional) are inoperable.

## 3 Select the desired copy size, image density level, reproduction ratio, etc. if necessary.

## 4 Press the START key.

- You can make multiple copies by pressing the START key once for each copy desired.

## 5 After interrupt copying is finished, press the INTERRUPT key again.

- The following message appears:

Ready to resume job 1

## 6 Replace the previous original and press the START key.

- The remaining number of copies of the previous multicopy run will be made automatically.

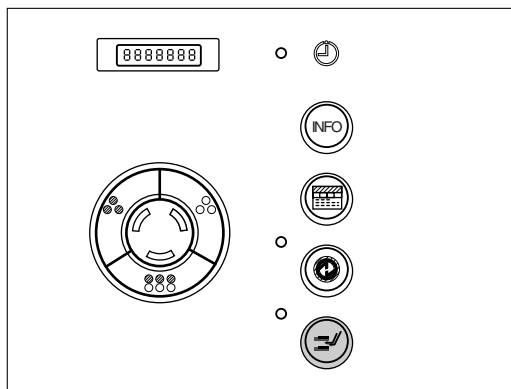

HOW TO  
MAKE  
COPIES

### Interrupt Copying during Printing

If you press the **COPY JOB REQUEST** key while the printer is being used, interrupt copying becomes available when the current printing job is completed.

The screen on the right appears during printing.

- If you want to make copies as soon as printing has been finished, press the **COPY JOB REQUEST** key.
- If you want to cancel the copy request, press the **CANCEL REQUEST** key





# 3. COLOUR EDITING AND ADJUSTMENT

1. Monocolour Copying . . . . .	52
2. Hue Adjustment . . . . .	53
3. Saturation . . . . .	54
4. Colour Balance (YMCK Adjustment) . . . . .	55
5. RGB Adjustment . . . . .	56
6. One-Touch Adjustment . . . . .	57
7. Background Adjustment . . . . .	58
8. Sharpness Adjustment . . . . .	59

# 1. MONOCOLOUR COPYING

You can select one colour out of 10 colours of the colour sample seal to make a monocolour copy.

## Procedure

- 1 Press the **COLOUR** key to enter the colour menu, then press the **MONOCOLOUR** key.

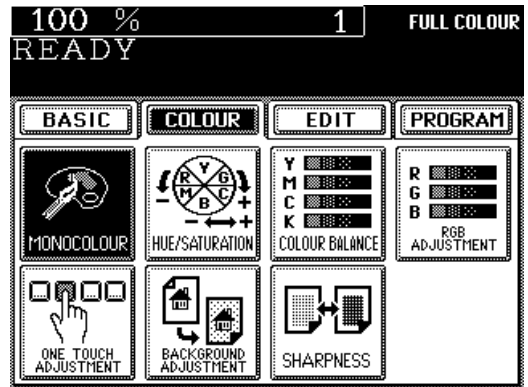

- 2 Press the desired copy colour key.
  - Press the **MAGENTA** key for instance.

**Note:** Refer to the colour sample seal above the touch panel.

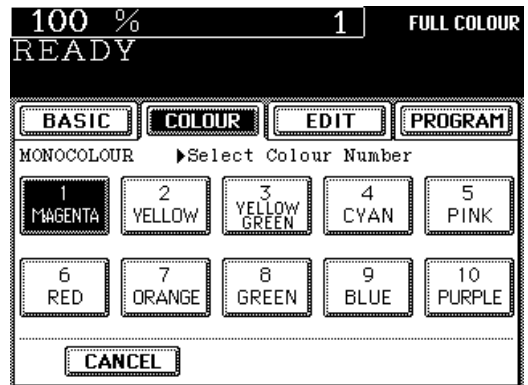

- 3 Select the desired copy size, image density level, copy quantity, etc. if necessary.

- 4 Press the **START** key.



# 2. HUE ADJUSTMENT

This function is available to adjust the hue by changing the hue circle.

## Procedure

**1** Press the **COLOUR** key to enter the colour menu, then press the **HUE/SATURATION** key.

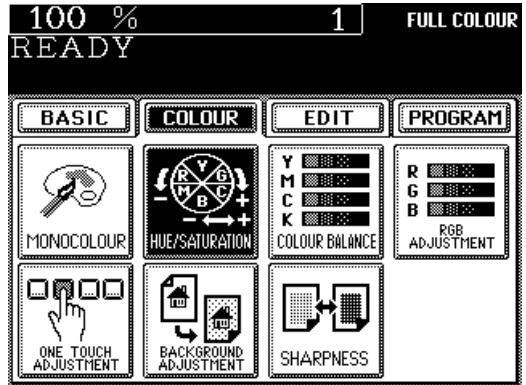

**2** Press the **HUE** key, then the **+** or **-** key to adjust the hue.

- Pressing the **+** key brings the colour closer to the next clockwise colour while pressing the **-** key brings it closer to the next anti-clockwise colour.

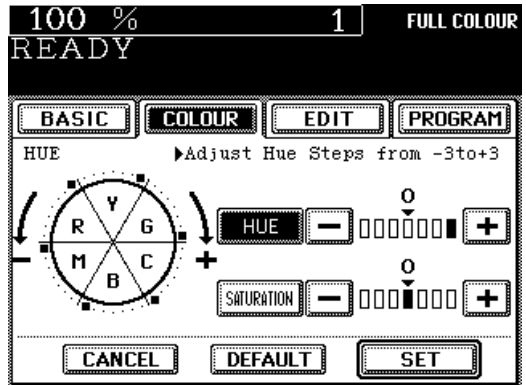

**3** Press the **SET** key.

**4** Select the desired copy size, image density level, the copy quantity, etc. if necessary.

**5** Press the **START** key.

## Cancelling the Hue Adjustment

There are two ways for clearing the setting.

- ① Press the **+** or **-** key on the HUE column to move the indicator to 0, then press the **SET** key.
  - ② Press the **DEFAULT** key, then the **SET** key.
- \*The saturation setting also becomes the default mode.

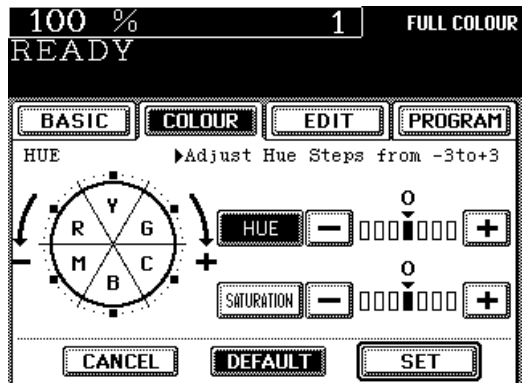

# 3. SATURATION

This function allows you to adjust the saturation of copies.

## Procedure

1 Press the **COLOUR** key to enter the colour menu, then press the **HUE/SATURATION** key.

2 Press the **SATURATION** key, then the **+** or **-** key to adjust the saturation.

- Pressing the **+** key increases the brightness while pressing the **-** key decreases the brightness.

3 Press the **SET** key.

4 Select the desired copy size, image density level, the copy quantity, etc. if necessary.

5 Press the **START** key.

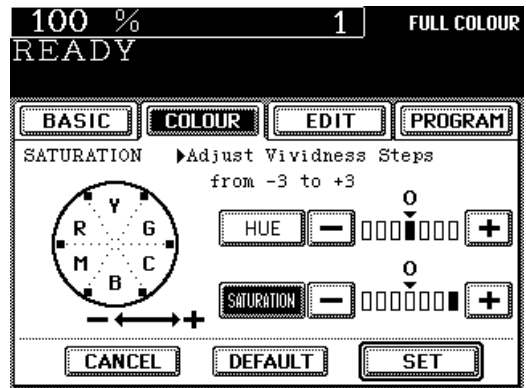
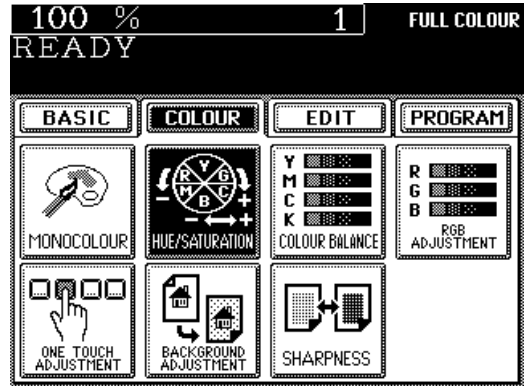

## Cancelling the Saturation Adjustment

There are two ways for clearing the setting.

- 1 Press the **+** or **-** key on the SATURATION column to move the indicator to 0, then press the **SET** key.
- 2 Press the **DEFAULT** key, then the **SET** key.  
\*The hue setting also becomes the default mode.

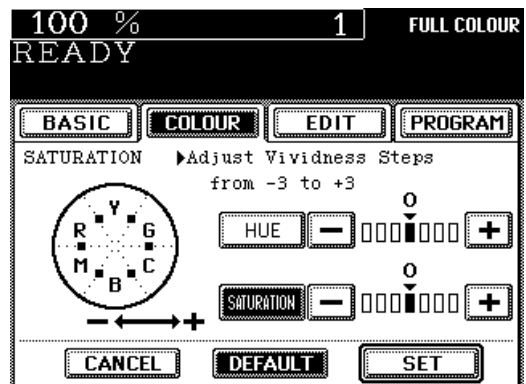

# 4. COLOUR BALANCE (YMCK ADJUSTMENT)

This function allows you to adjust the colour balance of copies by changing the strength of the primary colours (Yellow (Y), Magenta (M), Cyan (C) and Black (K)).

## Procedure

1 Press the **COLOUR** key to enter the colour menu, then press the **COLOUR BALANCE** key.

2 Press the **+** or **-** key to adjust the colour balance.

- Pressing the **+** key enhances the tint of the colour while pressing the **-** key decreases the tint of the colour.

3 Press the **SET** key.

4 Select the desired copy size, image density level, the copy quantity, etc. if necessary.

5 Press the **START** key.

## Cancelling the Colour Balance Adjustment

There are two ways for clearing the setting.

- ① Press the **+** or **-** key on the column you want to cancel to move the indicator to 0, then press the **SET** key.
- ② If you want to cancel all the 4 adjustments, press the **DEFAULT** key, then the **SET** key.

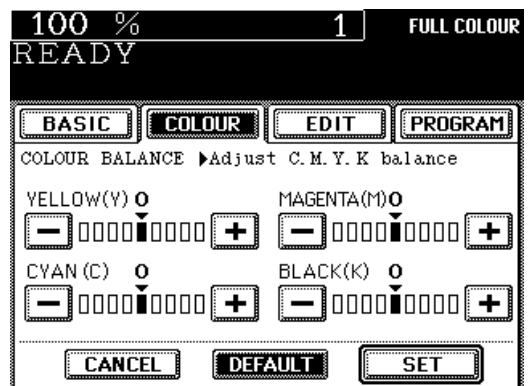
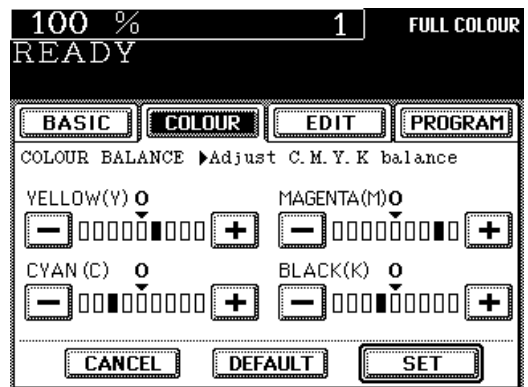
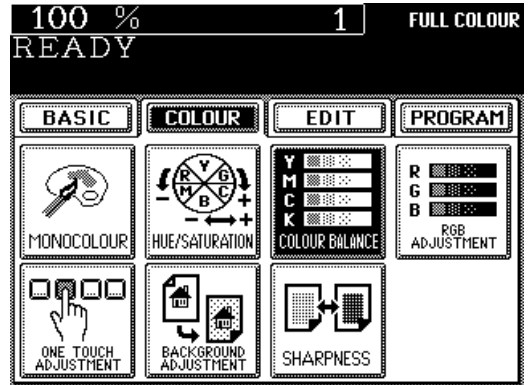

# 5. RGB ADJUSTMENT

This function allows you to adjust the colour balance by changing the strength of Red (R), Green (G) and Blue (B).

## Procedure

1 Press the **COLOUR** key to enter the colour menu, then press the **RGB ADJUSTMENT** key.

2 Press the **+** or **-** key to adjust the colour balance.

- Pressing the **+** key enhances the tint of the colour while pressing the **-** key decreases the the tint of the colour.

3 Press the **SET** key.

4 Select the desired copy size, image density level, the copy quantity, etc. if necessary.

5 Press the **START** key.

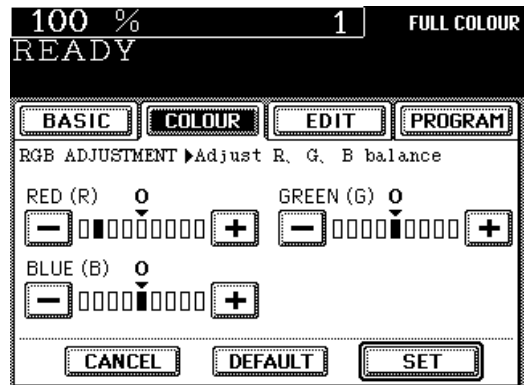
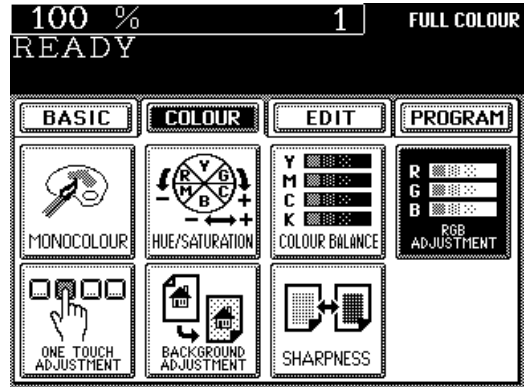

## Cancelling the Saturation Adjustment

There are two ways for clearing the setting.

- Press the **+** or **-** key on the column you want to cancel to move the indicator to 0, then press the **SET** key.
- If you want to cancel all the 3 adjustments, press the **DEFAULT** key, then the **SET** key.

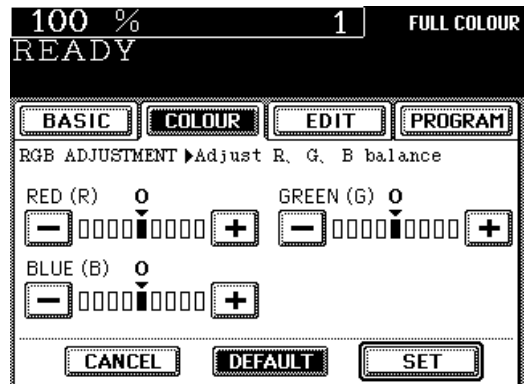

# 6. ONE-TOUCH ADJUSTMENT

You can make the image quality warm, cool, vivid or clear with one touch.

## Procedure

**1** Press the **COLOUR** key to enter the colour menu, then press the **ONE TOUCH ADJUSTMENT** key.

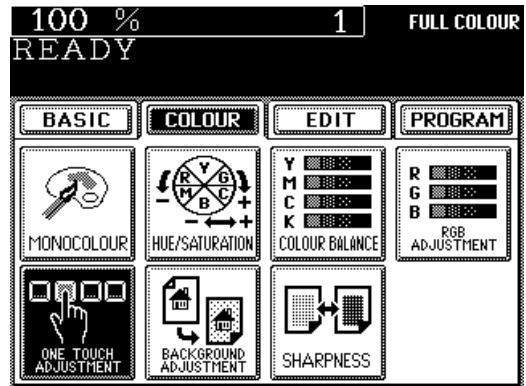

**2** Press the desired mode key.  
• Press the **WARM** key for instance.

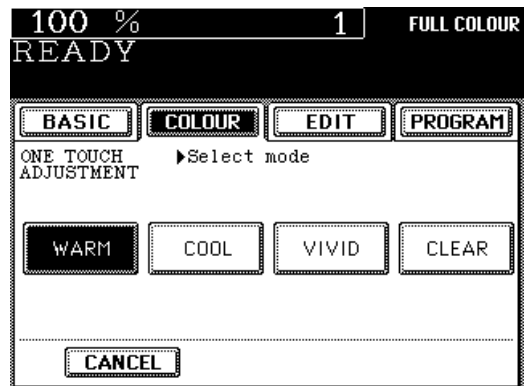

**3** Select the desired copy size, image density level, the copy quantity, etc. if necessary.

**4** Press the **START** key.

# 7. BACKGROUND ADJUSTMENT

This function allows you to emphasize the background of light colour originals or to avoid copying the background of dark colour originals or rear side of originals.

This function is available in the black or monocolour mode as well.

\* Automatic density mode is not available with this function.

## Procedure

1 Press the **COLOUR** key to enter the colour menu, then press the **BACKGROUND ADJUSTMENT** key.

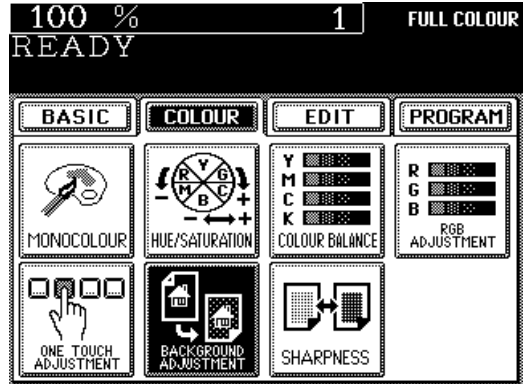

2 Press the **← LIGHT** or **DARK →** key.

3 Press the **SET** key.

4 Select the desired copy size, image density level, the copy quantity, etc. if necessary.

5 Press the **START** key.

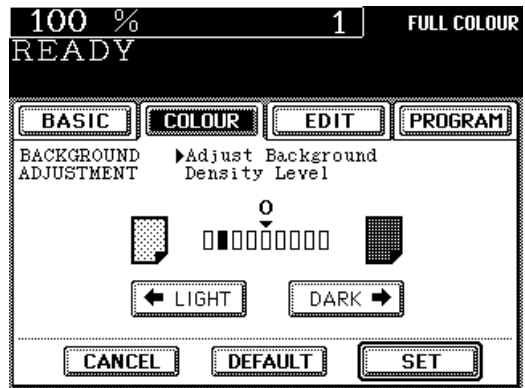

## Cancelling the Background Adjustment

There are two ways for clearing the setting.

- 1 Press the **← LIGHT** or **DARK →** key on the Background column to move the indicator to 0, then press the **SET** key.
- 2 Press the **DEFAULT** key, then the **SET** key.

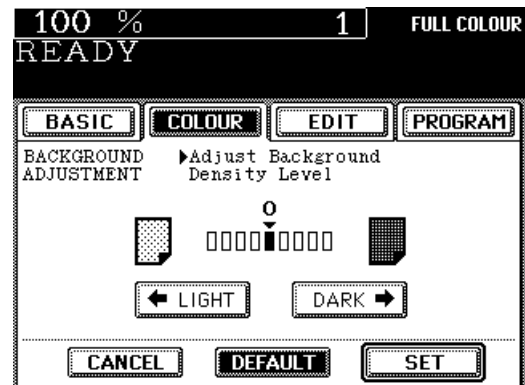

# 8. SHARPNESS ADJUSTMENT

This function is available when you want to emphasize the letters and edges of images. This function is available in the black or monocolour mode as well.

## Procedure

1 Press the **COLOUR** key to enter the colour menu, then press the **SHARPNESS** key.

2 Press the **←SOFT** or **SHARP→** key.  
• Pressing **←SOFT** key suppresses the moiré fringes while pressing the **SHARP→** key emphasizes the letters and sharpens the fine lines.

3 Press the **SET** key.

4 Select the desired copy size, image density level, the copy quantity, etc. if necessary.

5 Press the **START** key.

## Cancelling the Sharpness Adjustment

There are two ways for clearing the setting.

- 1 Press the **←SOFT** or **SHARP→** key on the Sharpness column to move the indicator to 0, then press the **SET** key.
- 2 Press the **DEFAULT** key, then the **SET** key.

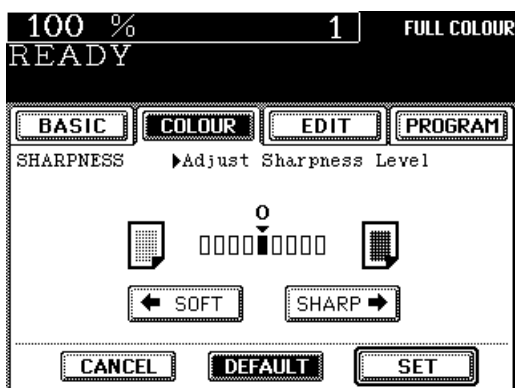
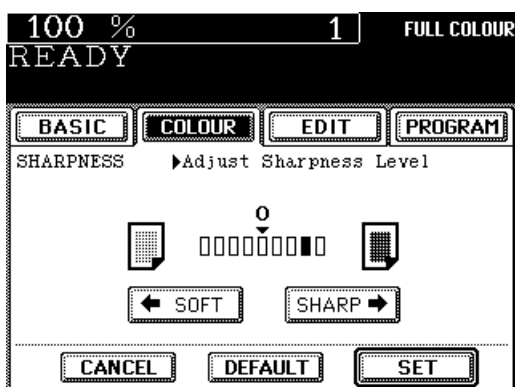
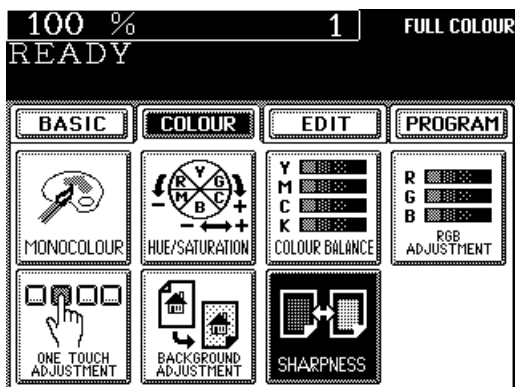





# 4. USING THE EDITING FUNCTIONS

1. Image Shift Copying . . . . .	62
2. Edge Erase Copying . . . . .	64
3. Book Centre Erase . . . . .	66
4. Dual-page Copying . . . . .	68
5. Full Image Copying . . . . .	70
6. 2 IN 1 Mode Copying . . . . .	71
7. Duplex Copying . . . . .	73
① Duplexed Copies from Single-sided Originals . . . . .	73
② Duplexed Copies from Two-sided Originals . . . . .	77
③ Single-sided Copies from Two-sided Originals . . . . .	78
④ Duplexed Copies from a Book Originals . . . . .	79
8. X-Y Zoom . . . . .	82
9. Trimming/Masking . . . . .	83
10. Mirror Image . . . . .	87
11. Negative/Positive Reversal . . . . .	88
12. Centring . . . . .	89
13. Image Repeat . . . . .	91

# 1. IMAGE SHIFT COPYING

You can create margins on the copy. You can specify the position of these margins on either the right or the left side of the copy. You can also create margins on copies of book originals by just using the DUAL PAGE mode.

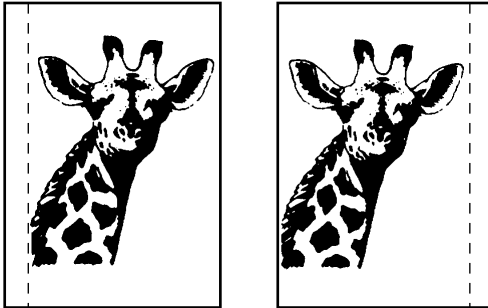

## Procedure

- 1 Press the **EDIT** key to enter the Edit menu, then press the **IMAGE SHIFT** key.

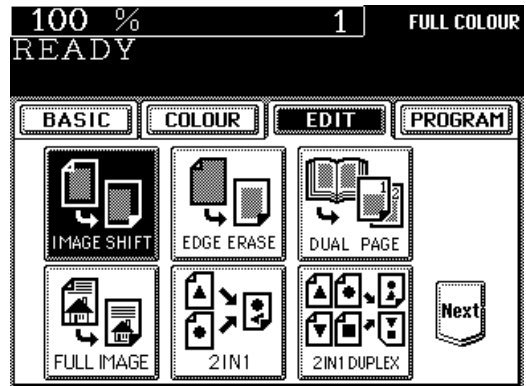

## Margin on the Left or Right Side

- 2 Select on which side the margin is to be created.
  - Press one of the **LEFT** or **RIGHT** keys to select the type of margin.

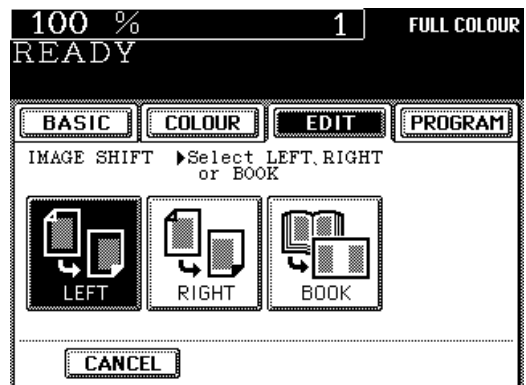

**3** After having adjusted the margin, press the **SET** key.

- The default margin is 7 mm.
- To adjust the margin:  
Press the **◀0mm** or **30mm▶** key to select the desired margin setting, and press the **SET** key.
- In duplex copying, margins in the back are created on the other side of those in the front. See page 73 for duplex copying.

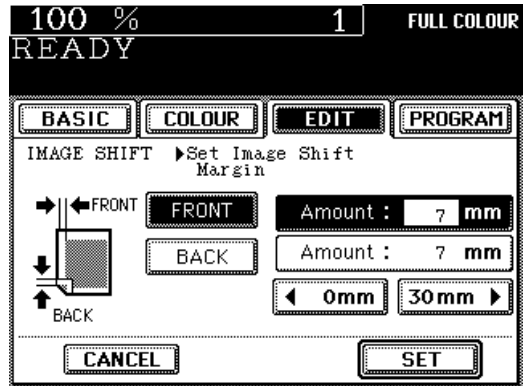

### Margin on the Book Originals

**2** Select on which side the margin is to be created.

- Press the **BOOK** key.
- If you select the **BOOK** margin, use it in conjunction with the **DUPLEX COPYING** mode from book originals (page 79) or **DUAL PAGE** mode (page 68).

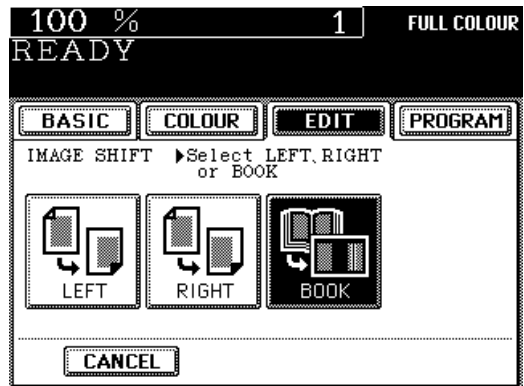

**3** After having adjusted the margin, press the **SET** key.

- The default margin is 14 mm.
- To adjust the margin:  
Press the **◀2mm** or **30mm▶** key to select the desired margin setting, and press the **SET** key.

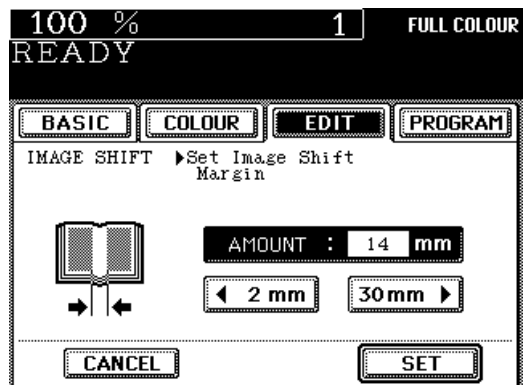

**4** Place the original on the glass.

- The book should be centred on the yellow indicator line with its bottom toward you.

**5** Select the desired copy size, image density level, reproduction ratio and copy quantity.

**6** Press the **START** key.

**Tip:** Margins can be created also in the bypass copy mode. To do this, set the paper in the sheet bypass (see page 42), and press the desired **COPY-SIZE** key to select the desired paper size.

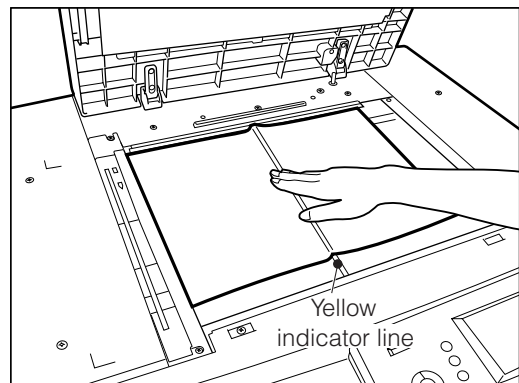

## 2. EDGE ERASE COPYING

If the edges of an original are torn or dirty, they are reproduced as black stains on the copy. In the edge erase mode, a white border is created along all edges of the copy. The default edge erase margin is 5 mm, but you can select any margin between 2 and 20 mm.

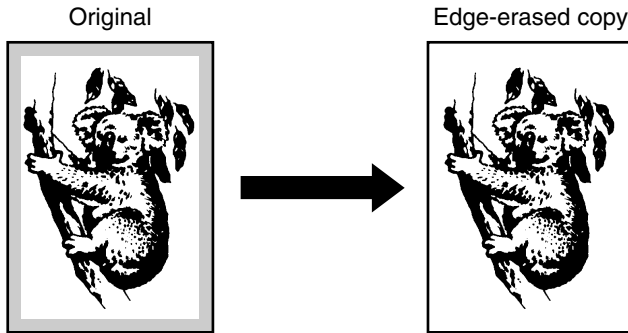

### Procedure

- 1 Press the **EDIT** key to enter the Edit menu.
- 2 Press the **EDGE ERASE** key.

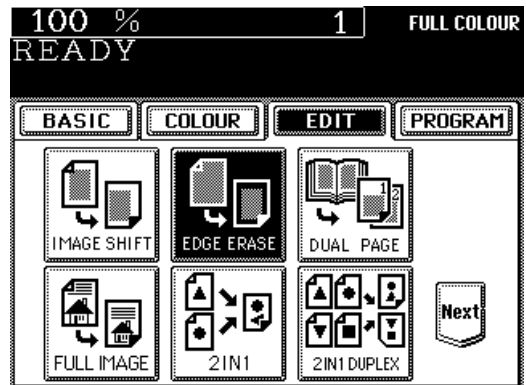

### How to Change the Edge Erase Margin

- The default edge erase margin is 5mm.
- To change the edge erase margin, press the **◀ 2mm** or **20mm ▶** key to select the desired edge erase margin.
- If the setting is OK, press the **SET** key.

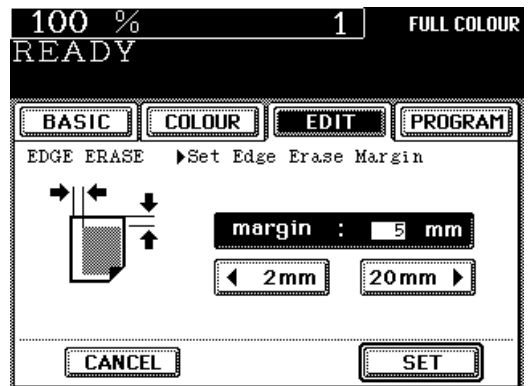

**3** Place the original(s) on the original feed tray or on the glass.

- See page 22 for how to set the originals.

**4** Select the desired copy size, image density level, reproduction ratio, copy quantity, etc. if necessary.

**5** Press the **START** key.

**Tip:** Edges can be erased also in the bypass copy mode. To do this, set the paper in the sheet bypass (see page 42), and press the desired COPY-SIZE key to select the desired paper size.

# 3. BOOK CENTRE ERASE

This function allows you to erase the shadow in the centre of a book original. The default book centre erase margin is 10mm, but you can select any margin between 2 and 50mm.

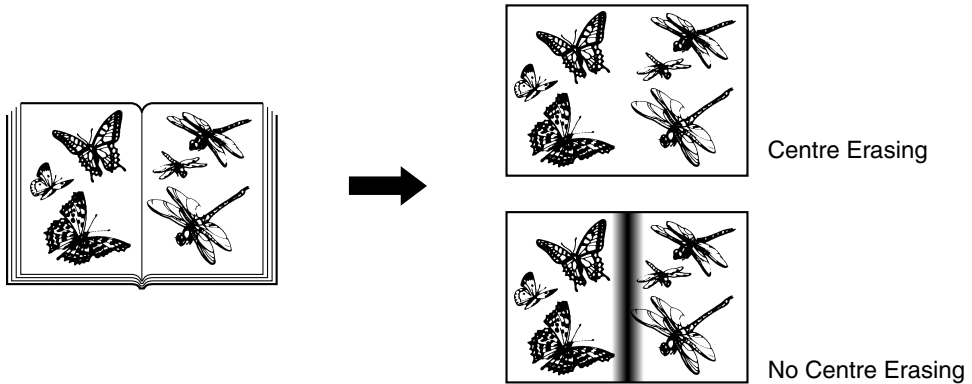

## Procedure

- 1 Press the **EDIT** key to enter the Edit menu.
- 2 Press the **Next** key to display the panel on the right.
- 3 Press the **BOOK CENTRE ERASE** key.

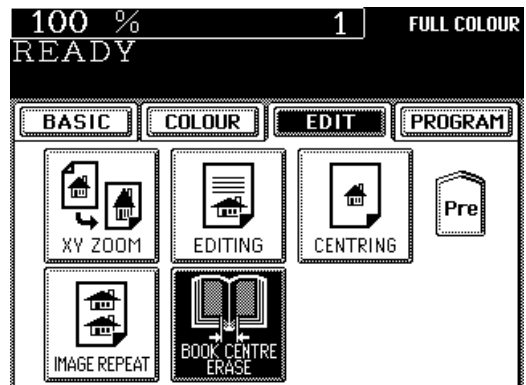

## Changing the Erased Margin

- The default book centre erase margin is 10mm.
- To change the margin to be erased, press the **◀ 2mm** key or **50mm ▶** key to set the desired margin.
- If the set value is correct, press the **SET** key.

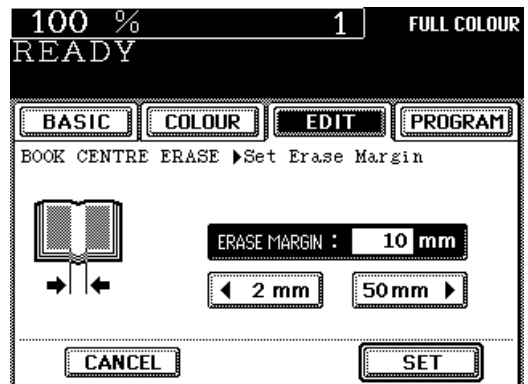

- 4** **Set the original(s) on the glass.**
  - The book should be centred on the yellow indicator line with its bottom toward you.
- 5** **Select the desired copy size, image density level, reproduction ratio, copy quantity, etc. if necessary.**
- 6** **Press the START key.**

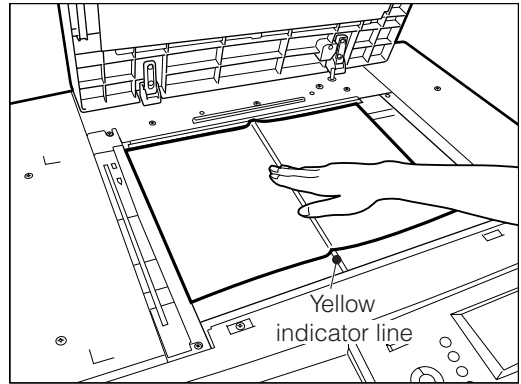

# 4. DUAL-PAGE COPYING

The facing pages of a book or magazine are copied one at a time onto two separate sheets of paper at the same time. You need not move the original on the glass.

\*The available paper size for this function is A4 only.

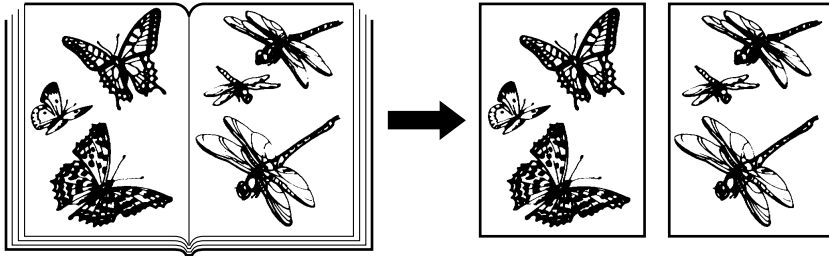

## Procedure

**1** Press the **EDIT** key to enter the Edit menu.

**2** Press the **DUAL-PAGE** key.

**3** Press the **1 SIDE** key for single-sided copying or the **2 SIDE** key for two-sided copying.

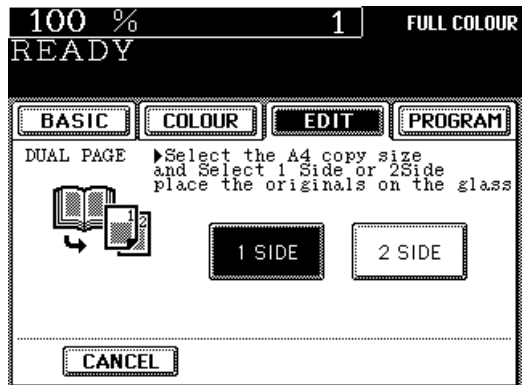
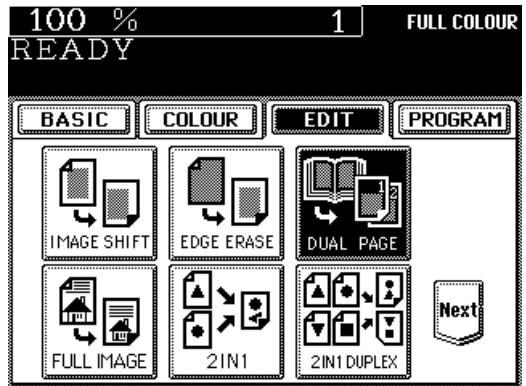



# 4

Select the A4 copy size.

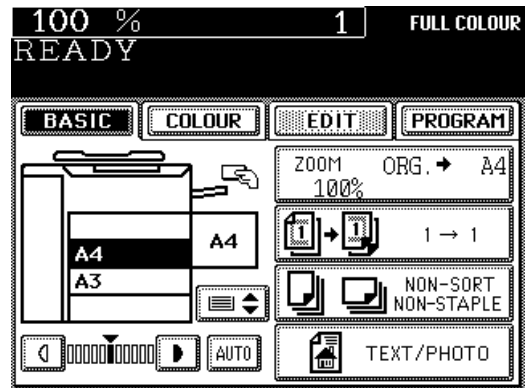

# 5

Place the original on the glass.

- The book should be centred on the yellow indicator line with its bottom toward you.

# 6

Select the desired image density level, copy quantity, etc. as required.

- To combine with the reduction and enlargement function, set the reproduction ratio before setting the original.

# 7

Press the START key.

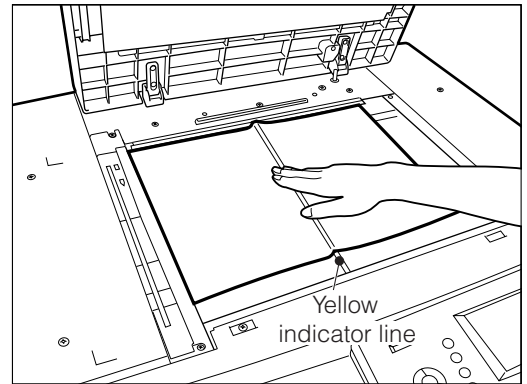

USING THE  
EDITING  
FUNCTIONS

# 5. FULL IMAGE COPYING

When the image occupies the entire original (to the edge), this function reduces the ratio a little bit so that the edges of the image will not be missed.

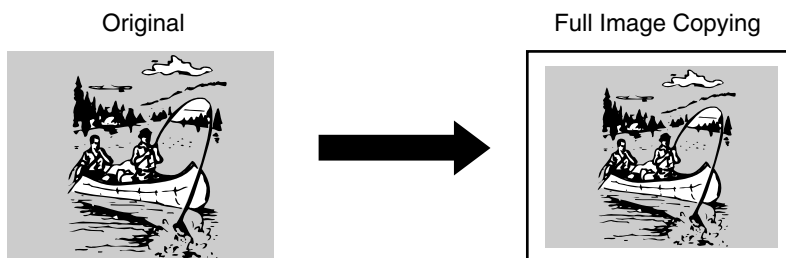

## Copying Procedure

- 1 Place the original(s) on the original feed tray or on the glass.**
  - See page 22 for how to set the original.

- 2 Press the **EDIT** key to enter the Edit menu.**

- 3 Press the **FULL IMAGE** key.**
  - The image is automatically reduced by a few percent so that the entire image is copied on a sheet.

- 4 Return to the Basic menu, then set the desired copy size, image density level, copy quantity, etc. if necessary.**

- 5 Press the **START** key.**

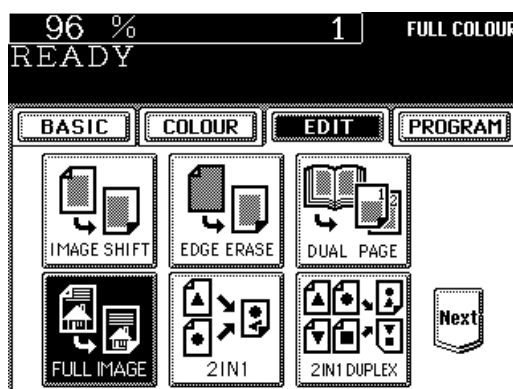

# 6. 2 IN 1 MODE COPYING

When you set A4 sized originals on the original feed tray and select the 2 in 1 function, the copier automatically feeds in the originals two at a time and causes them to be copied onto a single sheet of paper.

If you select the 2 in 1 duplex mode, four originals will be copied onto both sides of a single sheet of paper.

\* This copying mode requires the optional reversing automatic document feeder to be installed.

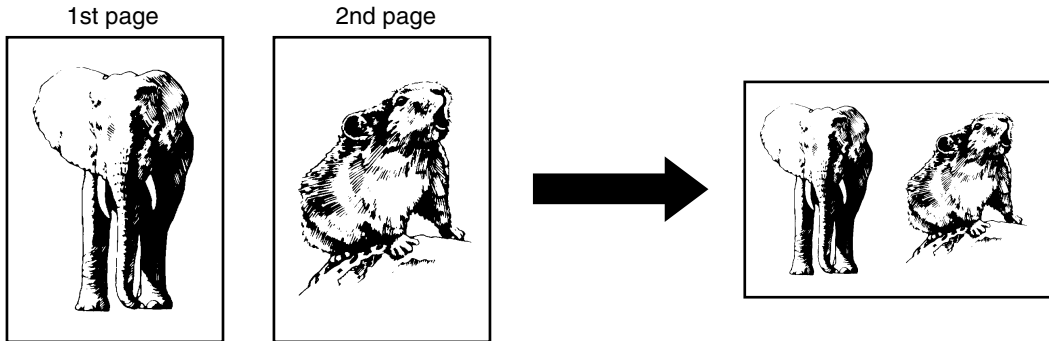

## Procedure

- 1 **Set the originals on the original feed tray.**
  - Refer to the illustration below for the order and direction of originals.

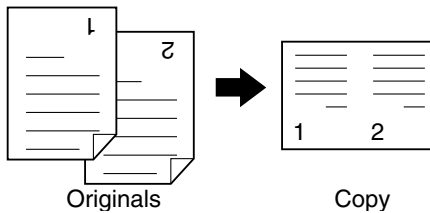

- 2 **Press the **EDIT** key to enter the Edit menu and press the **2 IN 1** key.**
  - When making a duplex copy, press the **2 IN 1 DUPLEX** key.

**Note:** The 2 in 1 duplex mode requires the optional automatic duplexer.

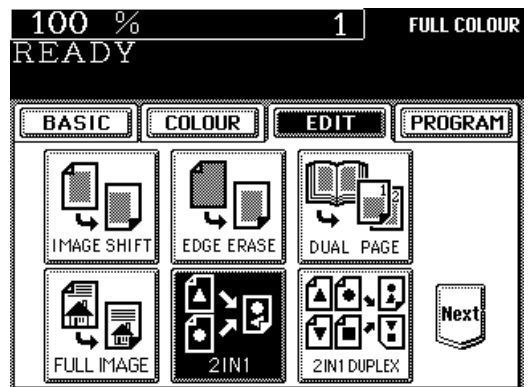

# 6. 2 IN 1 MODE COPYING (Cont.)

## 3 Enter the number of the originals.

- To have copies arranged in the correct page order in 2 in 1 copying, it is necessary to let the copier know the number of originals in one of the following ways:
- When the operator knows the number of originals:  
→ Key in the number of the originals.
- When making the copier count the number of originals:  
→ Press the **Original Count** key.  
The copier starts counting the originals automatically. When it finishes counting them, this message appears:

Put originals in doc. feeder

Then reset the originals in the original feed tray in the same way as described in step 1.

## 4 Press the **SET** key.

## 5 Set the desired image density level, copy quantity, etc.

- Maximum copy quantity for the 2 in 1 duplex copying is as shown below.  
80g/m<sup>2</sup> : 50 (all sizes)  
90g/m<sup>2</sup> : 40 (all sizes)

## 6 Press the **START** key.

**Note:** For automatic stapling in the 2 in 1 mode, the stapling position is the right bottom corner rather than the normal left upper corner of the copy, as shown on the right. If you want to staple on the left upper corner, change the direction when copying has been finished and use the manual stapling mode (see page 127).

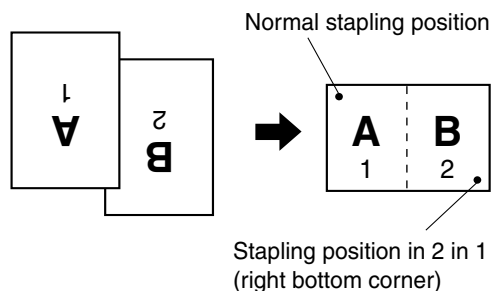
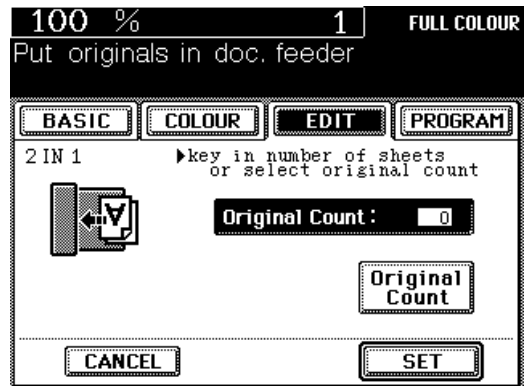

# 7. DUPLEX COPYING

## ① Duplexed Copies from Single-sided Originals

There are three methods of making duplexed copies from single-sided originals:

- **Using the reversing automatic document feeder** (optional) – For duplex-copying from sheet originals of the specified sizes and weights.
- **Setting originals on the glass** – For duplex copying from originals that cannot be handled by the reversing automatic document feeder, etc.
- **Using the dual-page function** (See page 68.) – For duplex copying from the facing pages of a book or two sheet originals (A4 size only) placed on the glass.

**Notes:**

- This copying mode requires the optional automatic duplexer to be installed.
- Duplex copying can be made in the plain paper (64-90g/m<sup>2</sup>) mode only.

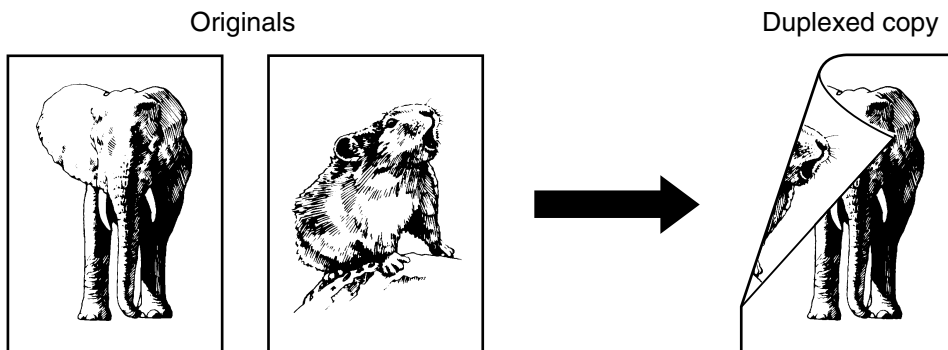

### When Using the Reversing Automatic Document Feeder

**1** Press the **1→1** key on the Basic menu.

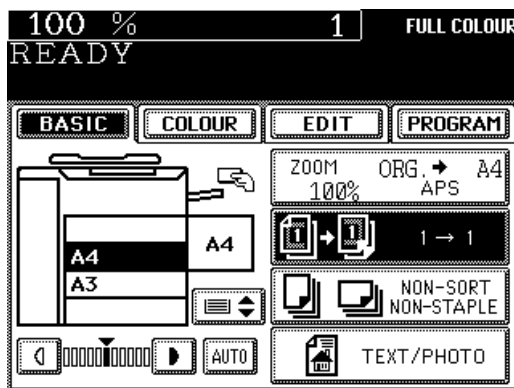

**2** Press the **1→2** key to select the function of single-sided originals to double-sided copies.

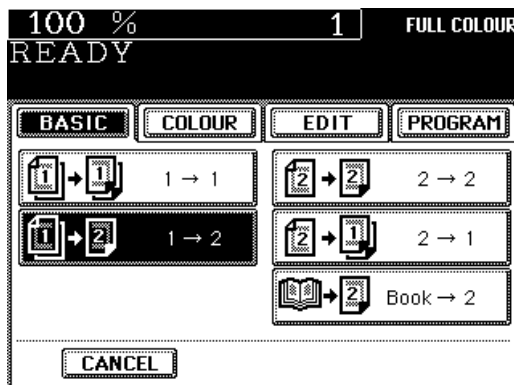

# 7. DUPLEXED COPYING (Cont.)

## 3 Press the **EVEN** or **ODD** key according to the number of originals.

When you do not know the number of originals, set them on the reversing automatic document feeder and press the **Original Count** key. The number of originals will be automatically counted. When the copier has finished counting the originals, press the **SET** key.

## 4 Select the desired copy size, image density level, reproduction ratio, copy quantity, etc. if necessary.

- The maximum number of copies is as shown below.
  - 80g/m<sup>2</sup> : 50 (all sizes)
  - 90g/m<sup>2</sup> : 40 (all sizes)

## 5 Place the originals.

- See page 22 for how to set the originals.

**Note:** Remove any paper clips or staples from originals before placing them on the original feed tray.

- When originals are placed to be fed from the top (or bottom) as shown on the right, invert the odd-numbered and even-numbered originals relative to each other as shown before setting them.

## 6 Press the **START** key.

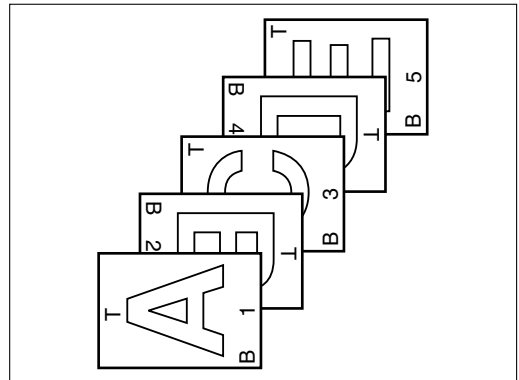
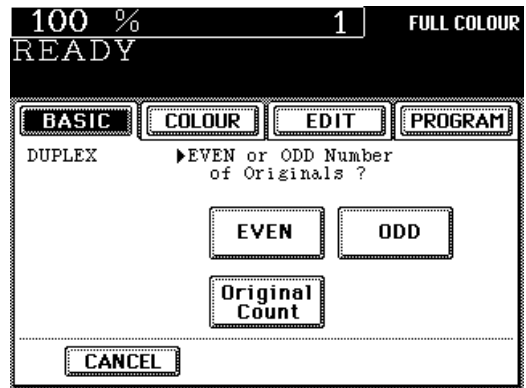

## When Placing the Original on the Glass

**1** Press the **1→1** key on the Basic menu.

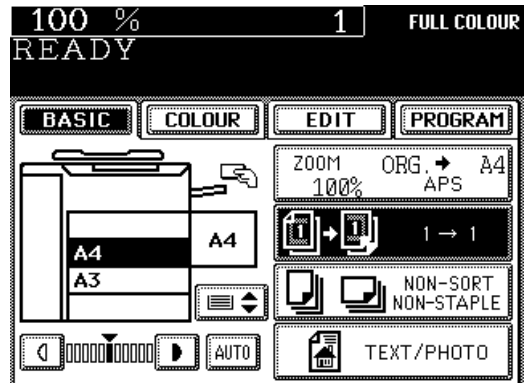

**2** Press the **1→2** key to select the function of single-sided originals to double-sided copies.

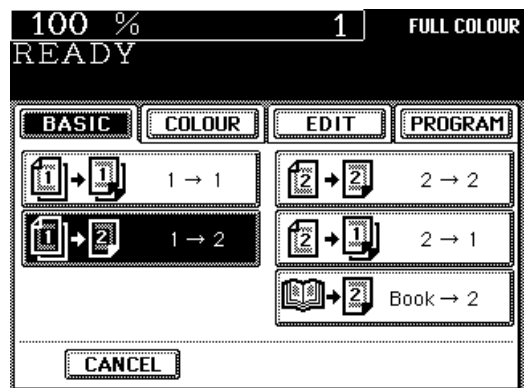

**3** Press the **EVEN** or **ODD** key according to the number of originals.

**Tip:** The original counting function is not available when the originals are placed on the glass.

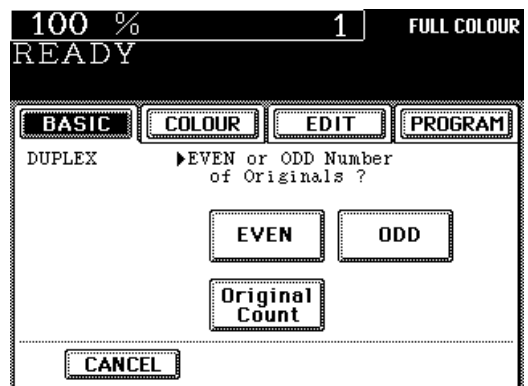

**4** Select the desired copy size, image density level, reproduction ratio, copy quantity, etc. if necessary.

- The maximum number of copies is as shown below.
  - 80g/m<sup>2</sup> : 50 (all sizes)
  - 90g/m<sup>2</sup> : 40 (all sizes)

# 7. DUPLEX COPYING (Cont.)

## 5 Place the last page of the originals (first side).

- Lifting the original cover or the reversing automatic document feeder, place the original on the glass **face down** and with its bottom toward you and with its top left aligned against the original scale on the left side.
- Copying with the last page first causes the copies made to be arranged in the correct page order.
- Close the original cover or the reversing automatic document feeder slowly.

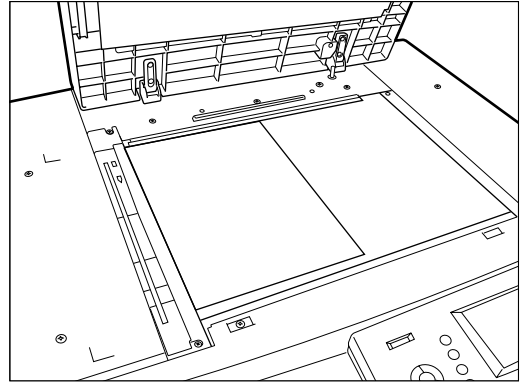

## 6 Press the **START** key.

## 7 Place the next original (second side).

- When the first-side original was placed vertically, the second-side original should be placed in the same direction.

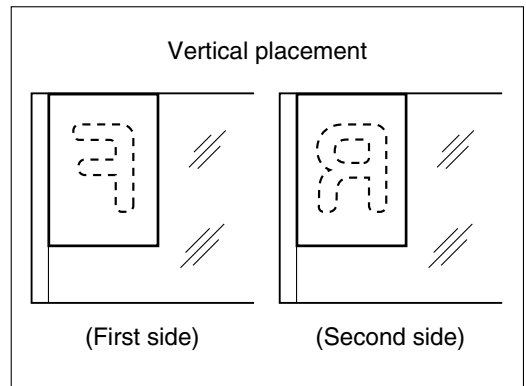

- When the first-side original was placed horizontally, the second-side original should be placed horizontally but in the opposite direction.

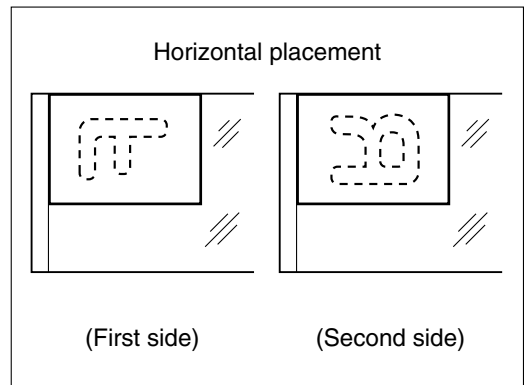

## 8 Press the **START** key.

- The same operation is available if you press the **START** key after having pressed the **YES** key.

## 9 Repeat step 5 to 8 until all the originals are copied.

## 10 Press the **FINISHED** key after all the originals have finished being copied.

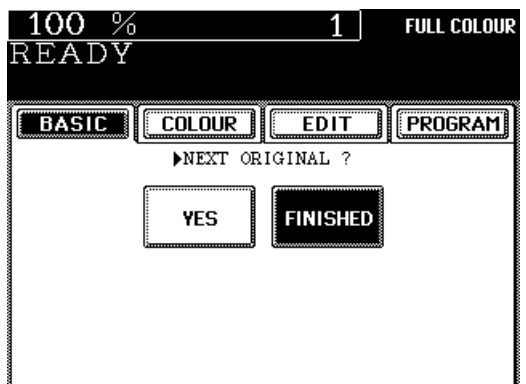



## ② Duplexed Copies from Two-sided Originals

- Notes:**
- This copying mode requires the optional automatic duplexer to be installed.
  - Duplex copying can be made in the plain paper (64~90g/m<sup>2</sup>) mode only.

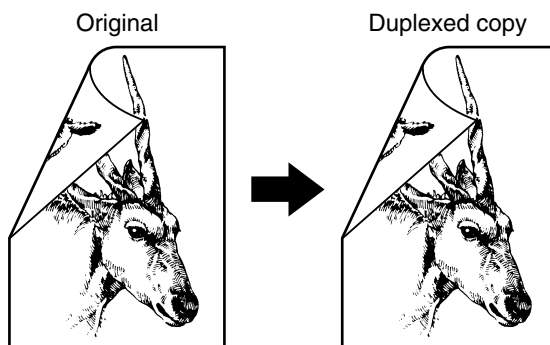

**1** Press the **1→1** key on the Basic menu.

**2** Press the **2→2** key.

**3** Select the desired copy size, reproduction ratio, image density level, copy quantity, etc. if necessary.

- The maximum number of copies is as shown below.
  - 80g/m<sup>2</sup> : 50 (all sizes)
  - 90g/m<sup>2</sup> : 40 (all sizes)

When Using the Reversing Automatic Document Feeder

**4** Place the originals.

- See page 22 for how to set the originals.

**5** Press the **START** key.

- The copier feeds one of the originals and copies the first side of the original onto a sheet. The original and the sheet are then turned over automatically and the second side of the original is copied onto the other side of the sheet.

When Placing the Original on the Glass

**4** Perform step 5 to 10 on page 76.

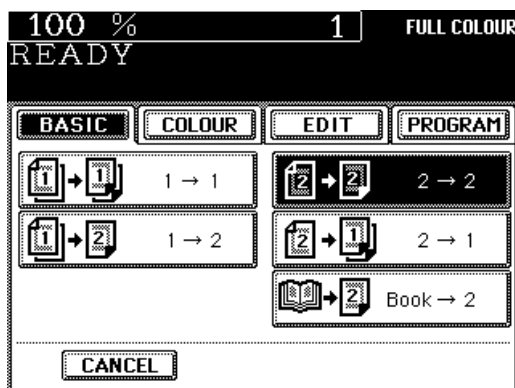
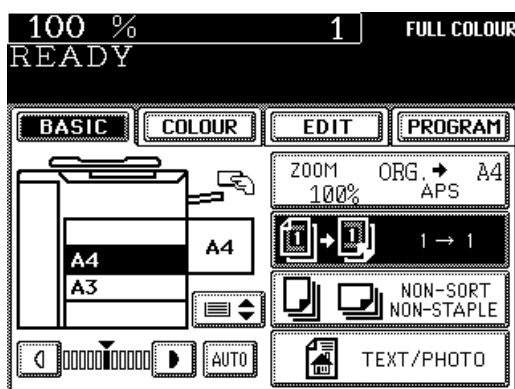

# 7. DUPLEX COPYING (Cont.)

## ③ Single-sided Copies from Two-sided Originals

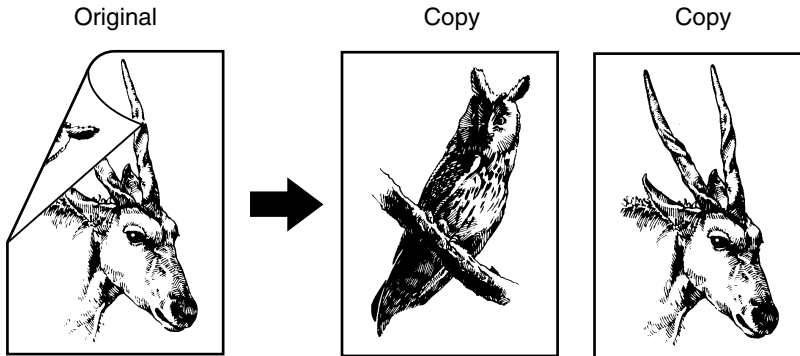

**1** Press the **1→1** key on the Basic menu.

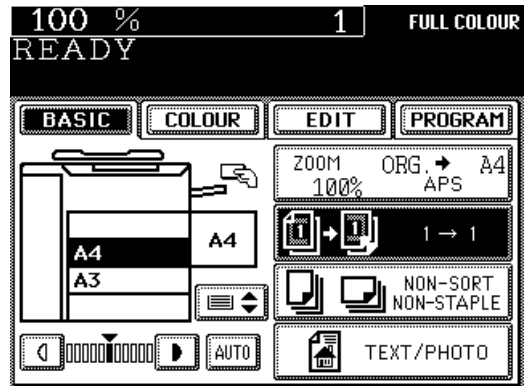

**2** Press the **2→1** key.

**3** Select the desired copy size, reproduction ratio, image density level, copy quantity, etc. if necessary.

- The maximum number of copies is as shown below.

80g/m<sup>2</sup> : 50 (all sizes)

90g/m<sup>2</sup> : 40 (all sizes)

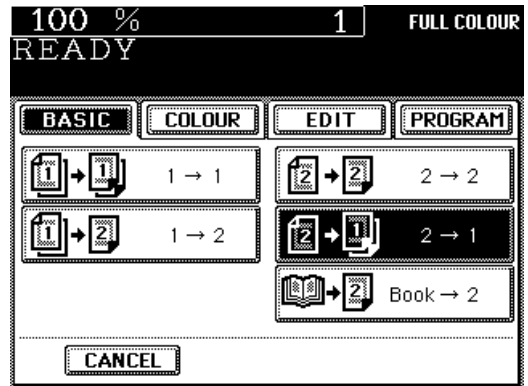

### When Using the Reversing Automatic Document Feeder

**4** Place the originals.

- See page 22 for how to set the originals.

**5** Press the **START** key.

- Single-sided copies are output from the copier.

### When Placing the Original on the Glass

**4** Perform step 5 to 10 on page 76.

## ④ Duplexed Copies from Book Originals

The copies made will be arranged in the same page order as the book.

- Notes:**
- This copying mode requires the optional automatic duplexer to be installed.
  - Duplex copying can be made in the plain paper (64~90g/m<sup>2</sup>) mode only.

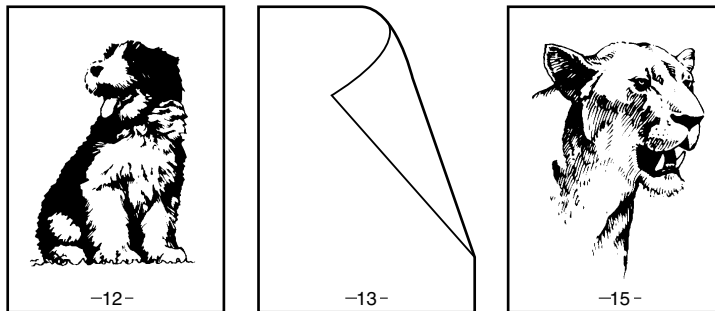
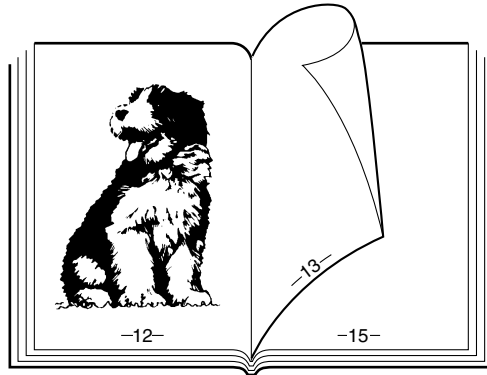

# 7. DUPLEX COPYING (Cont.)

**1** Press the **1→1** key on the Basic menu.

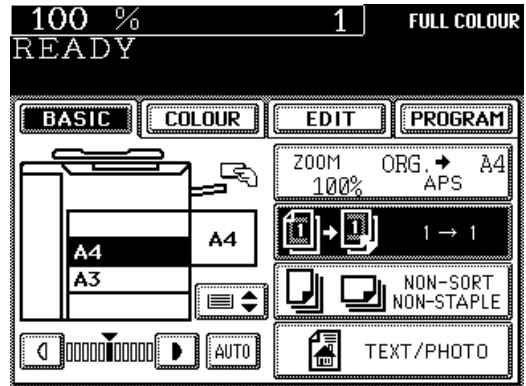

**2** Press the **BOOK→2** key.

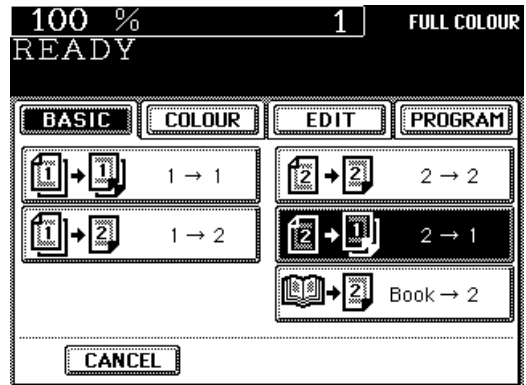

**3** Select the start and end page.

- Press the desired key.
- **RIGHT→RIGHT** Copying is started from a right page of the book and it ends on a right page.
- **RIGHT→LEFT** Copying is started from a right page of the book and it ends on a left page.
- **LEFT→LEFT** Copying is started from a left page of the book and it ends on a left page.
- **LEFT→RIGHT** Copying is started from a left page of the book and it ends on a right page.

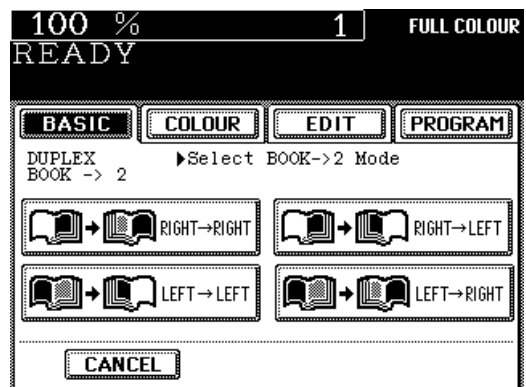

**4** Select the copy size.

- Press the A4 COPY-SIZE key.

**5** Select **IMAGE SHIFT** if necessary.

- See page 62.

**6** Select the desired image density level, reproduction ratio, copy quantity, etc. if necessary.

- The maximum number of copies is as shown below.  
80g/m<sup>2</sup> : 50 (all sizes)  
90g/m<sup>2</sup> : 40 (all sizes)

**7** Place the original and press the **START** key.

- The book should be centred on the yellow indicator line with its bottom toward you.
- Copying with the last page first causes the copies made to be arranged in the correct page order.

**8** Set the next original.

- Turn over the leaf of the book and set it in the same way as previously.

**9** Press the **START** key.

- Pressing the **YES** key on the display on the right also continues copying.

**10** Repeat steps 8 and 9 until you finish copying the book.

**11** Press the **FINISHED** key after all the originals have finished being copied. Press the **COPY FINAL PAGE** key if the last original has only one page.

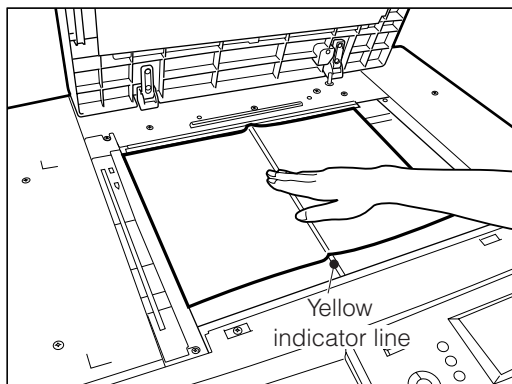
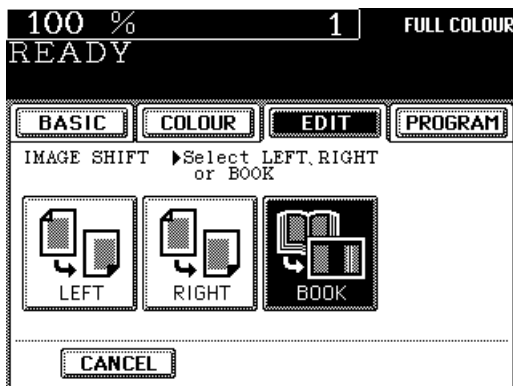

USING THE  
EDITING  
FUNCTIONS

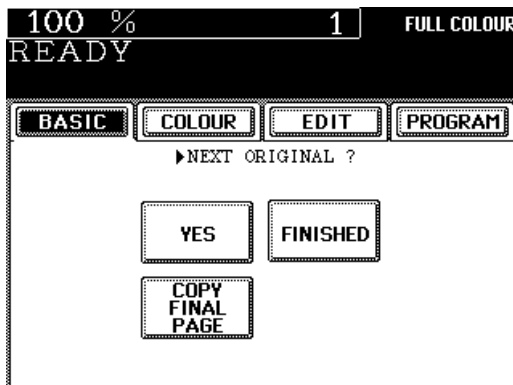

# 8. X-Y ZOOM

This function allows you to make copies of originals with the reproduction ratio of the X and Y directions changed.

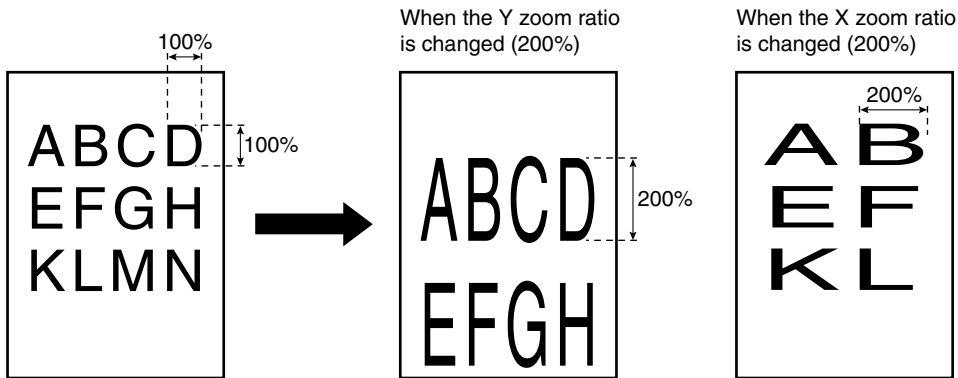

## Procedure

**1** Press the **EDIT** key to enter the Editing menu, then press the **Next** key.

**2** Press the **XY ZOOM** key.

**3** Specify the X and Y reproduction ratios.

- Press the **25%<** or **>400%** key on the display to select the X reproduction ratio, and press the upper **SET** key.
- Select the Y reproduction ratio in the same way.

**4** Press the lower **SET** key.

**5** Select the desired copy size, image density level, copy quantity, etc. if necessary.

**6** Place the original(s) on the original feed tray or on the glass and press the **START** key.

- See page 22 for how to set the originals.

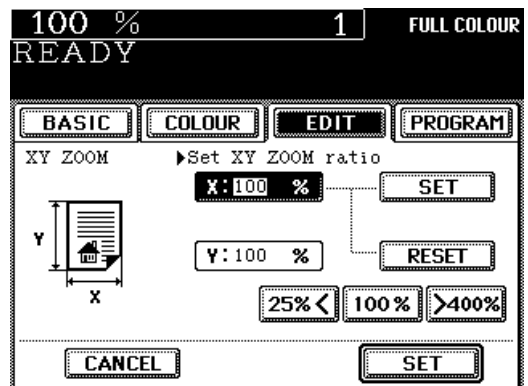
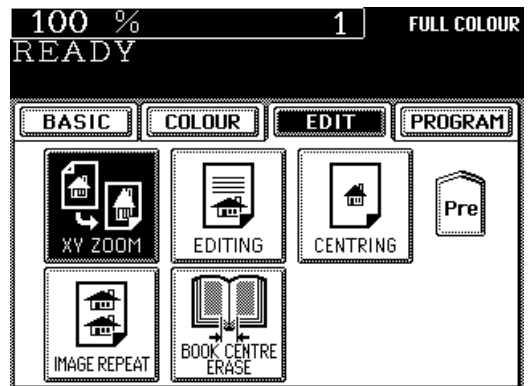

# 9. TRIMMING/MASKING

This function allows you to trim or mask copies.

You can trim originals (extracting inside area only) by selecting the trimming mode, and you can mask originals (hiding inside area) by selecting the masking mode. You can specify areas by placing originals on the glass.

\* You can specify only one rectangular place on a single original.

\* Only the standard size originals are available for this mode.

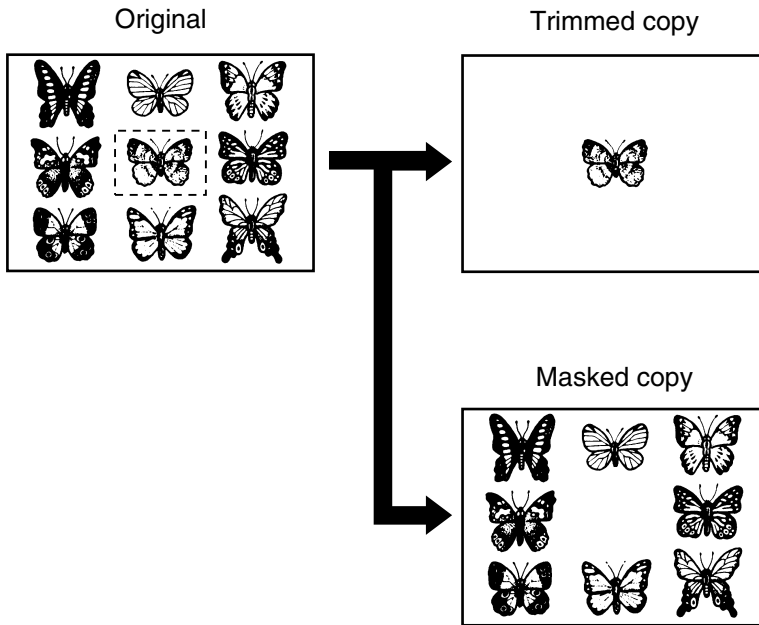

# 9. TRIMMING/MASKING (Cont.)

## Specifying an area

- 1 Place the original face up on the glass with its bottom edge towards you and its top left aligned against the top left of the glass. Align the original with the original scale on the left.

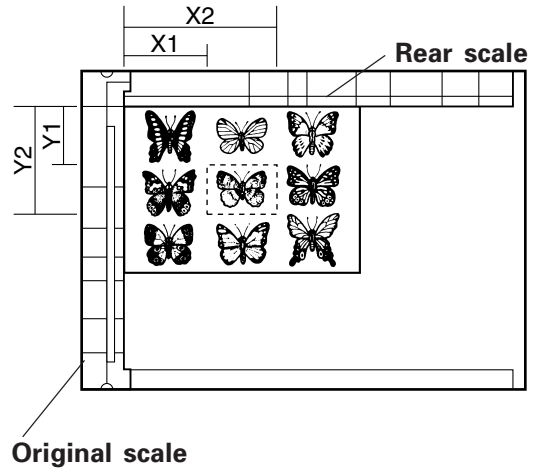



## 2 Using the original scale and the rear scale, specify the values defining the desired area as follows:

- X1 •• Distance from the original scale to the left edge of the specified area
- X2 •• Distance from the original scale to the right edge of the specified area
- Y1 •• Distance from the rear scale to the upper edge of the specified area
- Y2 •• Distance from the rear scale to the lower edge of the specified area

## 3 Specify the area of the original. (To display the screen on the right, follow steps 1-3 in the "Procedure" below.)

- Key in the value X1 using the digital keys and press the upper **SET** key. If you key in a wrong value, press the **RESET** key.
- Values X2, Y1 and Y2 require the same procedure as X1.

## 4 Press the lower **SET** key.

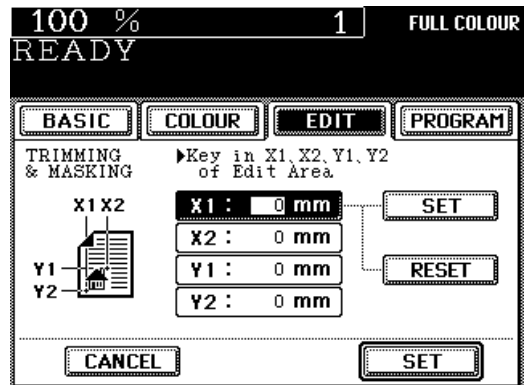

USING THE EDITING FUNCTIONS

## Procedure

### 1 Press the **EDIT** key to enter the Editing menu, and then press the **Next** key.

### 2 Press the **EDITING** key.

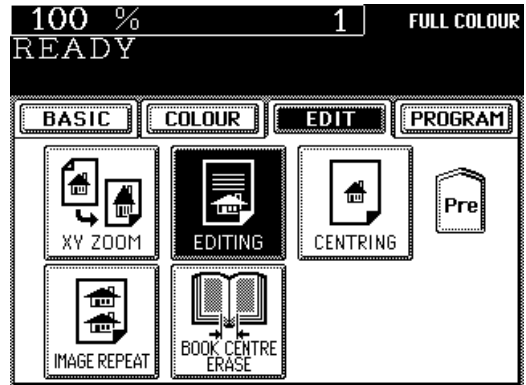

### 3 Press the **TRIM** or **MASK** key.

### 4 Place the original face up on the glass with its bottom edge towards you and its top left aligned against the top left of the glass.

**Tip:** Only the standard size originals are available for this mode.

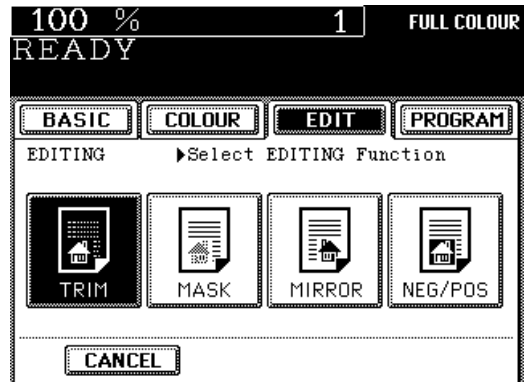

# 9. TRIMMING/MASKING (Cont.)

**5** Following the method of specifying areas on page 84, key in the size of the area to be trimmed or masked with the digital keys, then press the **SET** key.

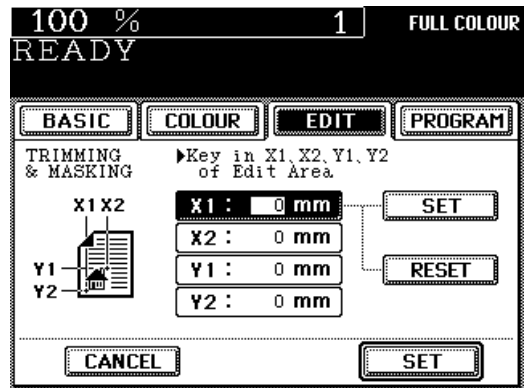

**6** Place the original on the glass face down with its bottom toward you and with its top left aligned against the original scale on the left side.

**7** Select the desired copy size, image density level, copy quantity, etc. if necessary.

**Tips:**

- If the setting of original size and copy size is not appropriate, the image may not be copied completely.
- In bypass copying, the copy size must be specified.

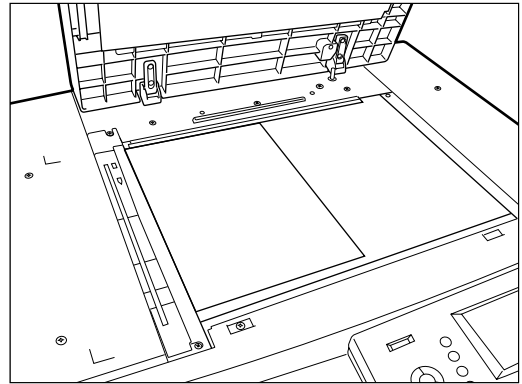

**8** Press the **START** key.  
Trimmed or masked copies exit from the copier.

# 10. MIRROR IMAGE

This function allows you to make mirror-imaged copies of the entire original.

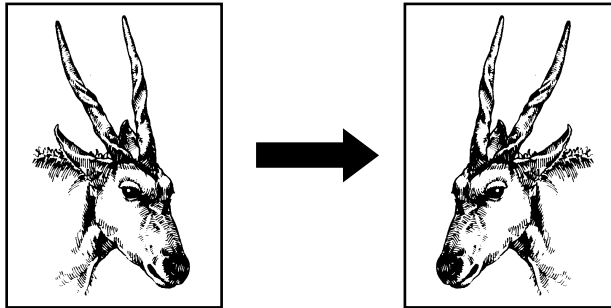

## Procedure

- 1 Press the **EDIT** key to enter the Editing menu, and then press the **Next** key.
- 2 Press the **EDITING** key.
- 3 Press the **MIRROR** key.
- 4 Select the desired copy size, image density level, reproduction ratio, copy quantity, etc. if necessary.
- 5 Place the original(s) on the original feed tray or on the glass and press the **START** key.
  - See page 22 for how to set the originals.

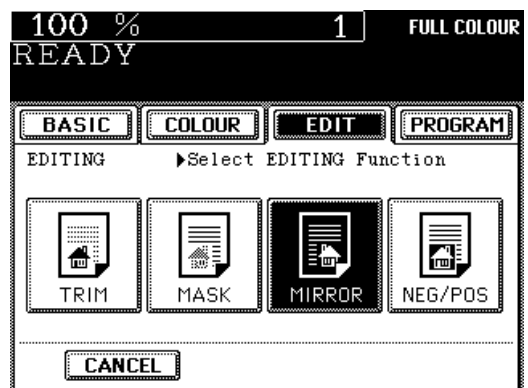
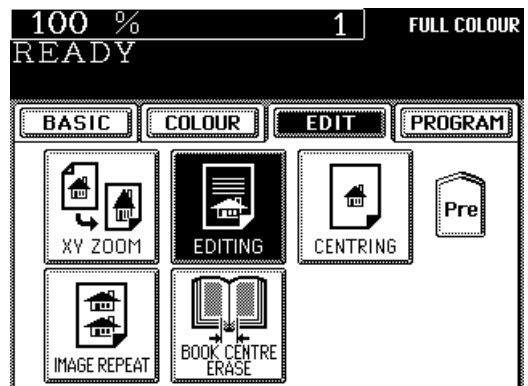

# 11. NEGATIVE/POSITIVE REVERSAL

In the full colour mode, this function allows you to reverse both hue and shading of the entire original when making copies. In the black mode or monocolour mode, only the shading of the entire original is reversed.

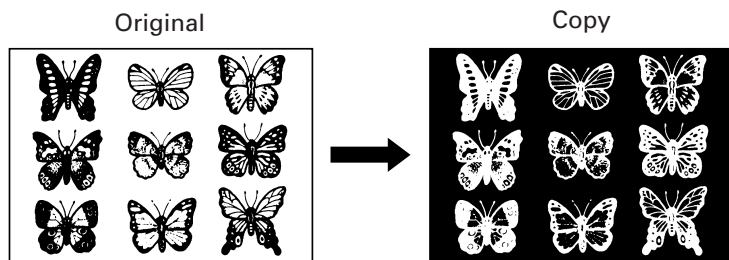

## Procedure

- 1 Press the **EDIT** key to enter the Editing menu, and press the **Next** key.
- 2 Press the **EDITING** key.
- 3 Press the **NEG/POS** key.
- 4 Select the desired copy size, image density level, reproduction ratio, copy quantity, etc. if necessary.
- 5 Place the original(s) on the original feed tray or on the glass.
  - See page 22 for how to set the originals.
- 6 Press the **START** key.

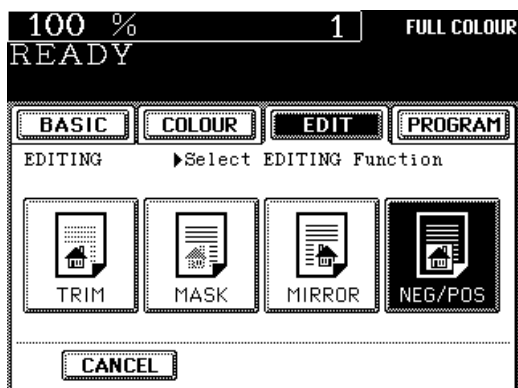
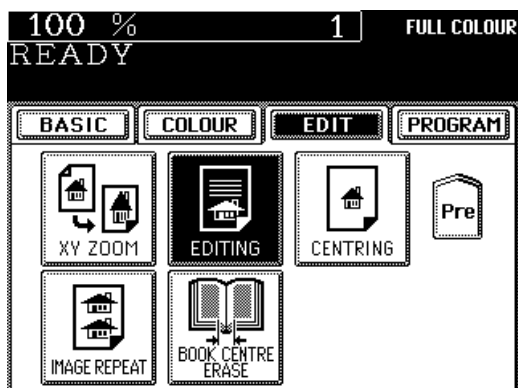

# 12. CENTRING

This function allows you to trim all of or a part of the original and print it out in the centre of a copy sheet.

\* This mode is available only for the standard size originals.

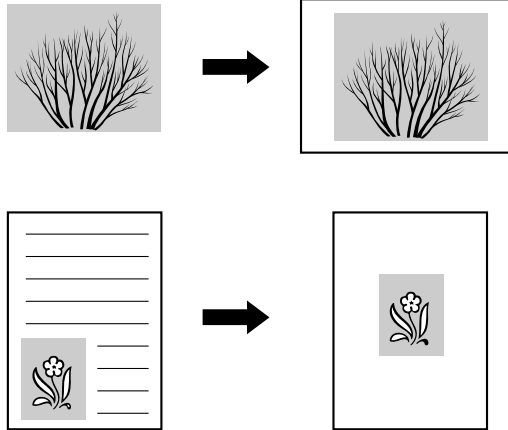

## Procedure

1 Press the **EDIT** key to enter the Edit menu, then press the **Next** key.

2 Press the **CENTRING** key.

3 Press the **ALL** or **PART** key to select the area for centring.

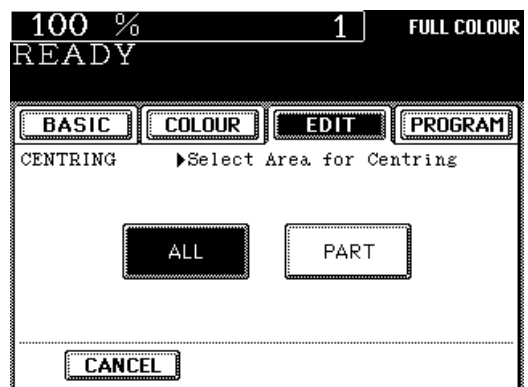
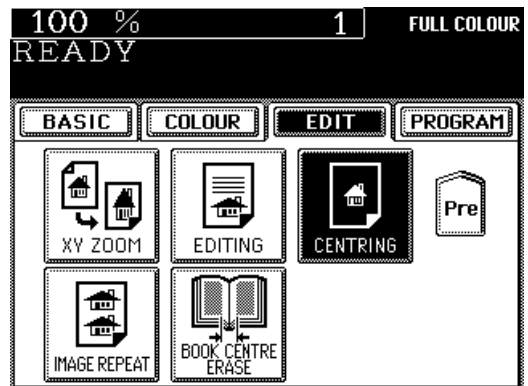

# 12. CENTRING (Cont.)

## When Centring the Entire Image of an Original

**4** Place the original on the glass face down with its bottom toward you and with its top left aligned against the original scale on the left side.

**5** Press the **BASIC** key to return to the Basic menu, then select the desired copy size, image density level, copy quantity, etc. if necessary.

**Tip:** If the setting of original size and copy size is not appropriate, the image may not be copied completely.

**6** Press the **START** key.

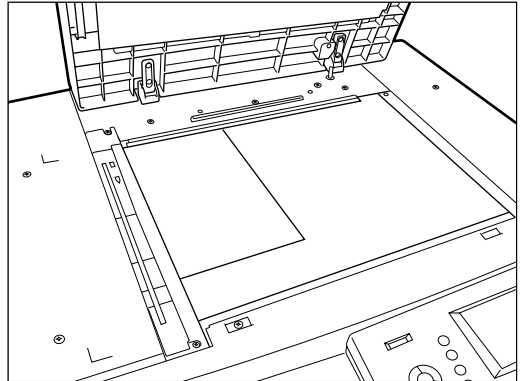

## When Centring a Part of an Original

**4** Place the original on the glass face up with its bottom toward you and with its top left aligned against the original scale on the left side.

**5** Following the "Specifying an area" on page 84, key in the size of the area to be centred with the digital keys, then press the **SET** key.

**6** Place the original on the glass face down and with its bottom toward you and with its top left aligned against the original scale on the left side.

**7** Select the desired copy size, image density level, copy quantity, etc. if necessary.

**Tip:** If the setting of original size and copy size is not appropriate, the image may not be copied completely.

**8** Press the **START** key.

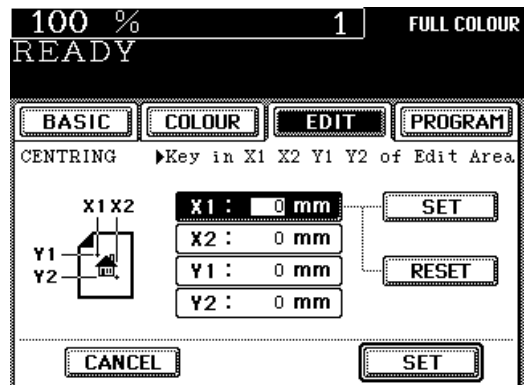

# 13. IMAGE REPEAT

This function allows you to repeat the entire original or a part of the area of the original on the copy.

\* This mode is available only for the standard size originals.

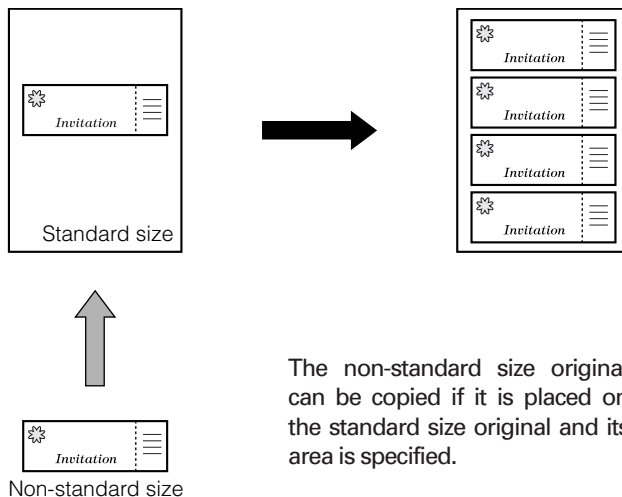

The non-standard size original can be copied if it is placed on the standard size original and their area is specified.

## Procedure

- 1 Press the **EDIT** key to enter the Edit menu, and then press the **Next** key.
  - The display on the right appears.
- 2 Press the **IMAGE REPEAT** key.

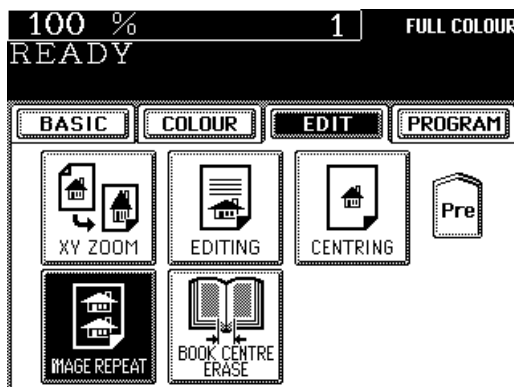

# 13. IMAGE REPEAT (Cont.)

**3** Place the original on the glass face up with its bottom toward you and with its top left aligned against the original scale on the left side.

**4** Following the "Specifying an Area" on page 84, key in the values of the area to be repeated (X1, X2, Y1 and Y2) with the digital keys and press the lower **SET** key.

- If the entire original will be repeated:  
X1=0(mm), Y1=0(mm)  
X2, Y2=arbitrary

**5** Place the original on the glass face down with its bottom toward you and with its top left aligned against the original scale on the left side.

**6** Set the repeat number.

- To change the repeat number:  
Press the **◀ 2** or **8 ▶** key to select the desired repeat number, and press the **SET** key.

**Tip:** If the repeat number is not set, the copier automatically repeats the original once. Only the length direction is available for repeat copying, and the original can be repeated up to 8 times.

**7** Select the desired copy size, image density level, copy quantity, etc. if necessary.

**8** Press the **START** key.

**Tip:** If the setting of the paper size or the repeat number is not made appropriately, the image may not be copied completely.

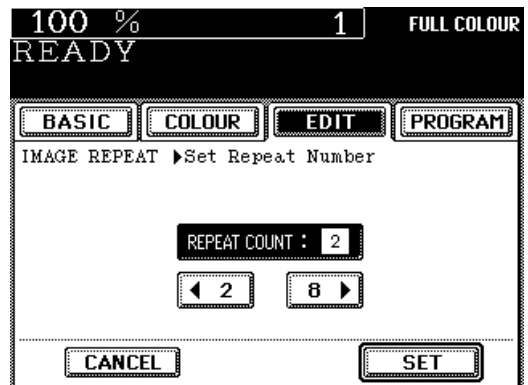
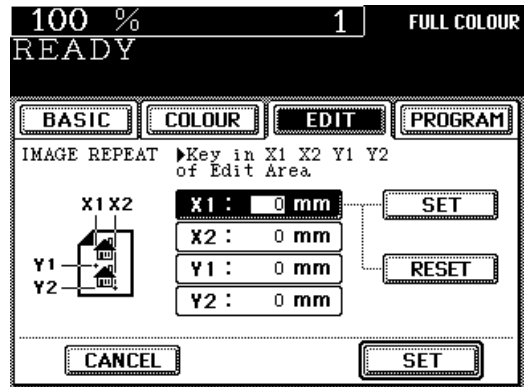



# 5. USING THE SPECIAL FUNCTIONS

1. Automatic Calibration . . . . .	94
2. Setting the Date and Time . . . . .	97
3. Weekly Timer . . . . .	99
4. Mode Memory . . . . .	101
5. Copying Using Paper of Universal Sizes . . . . .	103
6. Access Codes (ID Numbers) . . . . .	107
7. Total Counter . . . . .	108
8. Department Management . . . . .	109
9. Key Copy Counter . . . . .	117
10. Change of Language on the Display Panel . . . . .	118
11. User Selection (Initial Settings) . . . . .	119

# 1. AUTOMATIC CALIBRATION

This function allows the copier to automatically calibrate the colour gradation when the colour cannot be adjusted well because the shading or the hue of the image has deviated.

- Set the A3-sized paper in the cassette before starting the calibration.
- Be sure to use the paper recommended by Toshiba. If any other paper is used, the calibration may not be performed properly.
- If the colour often deviates, call your service technician.

**1** Press the **PROGRAM** key to enter the Programme menu.

**2** Press the **Next** key, then press the **CALIBRATION** key.

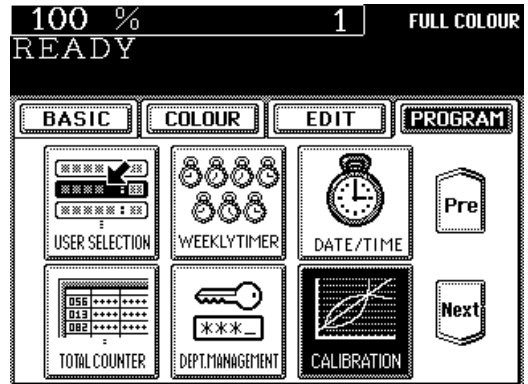

**3** Enter the password (4 digits) of your administrator (key operator), then press the **SET** key.

**Tip:** If you do not need the user control by the password of the administrator, tell your service technician.

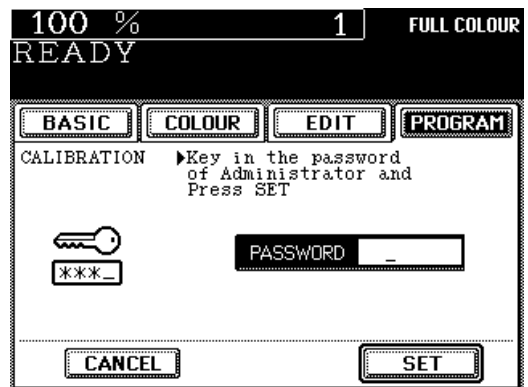

**4** Press the **CALIBRATION** key.

- The following message appears:

**WAIT**  
Wait for a few seconds.

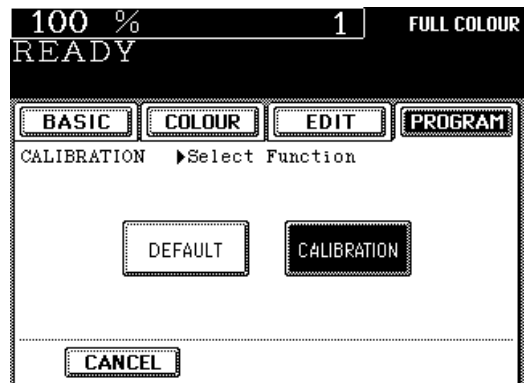

**5** Press the **TEST PRINT** key to print out the chart for calibration.

**6** Press the **CALIBRATION** key after the chart has been output.

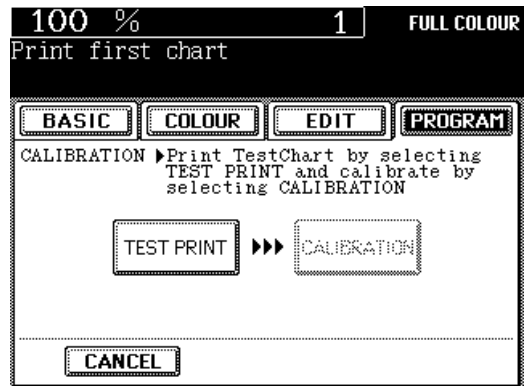

**7** When the display on the right appears, set the chart face down on the glass and with its bottom toward you and its top left aligned against the original scale on the left side, in order that the black line comes to the left side.

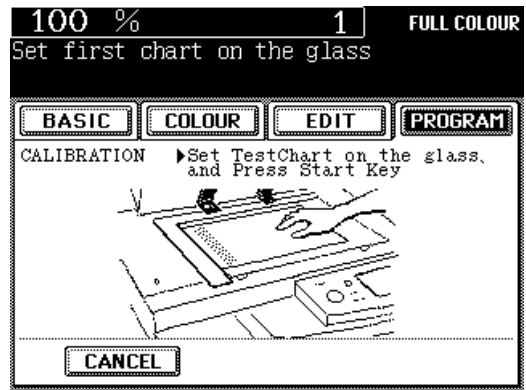

**8** Press the **START** key to start the first calibration.

- If the chart is not properly set, the following message appears:

Set chart correctly

Repeat the calibration in step 6.

**Notes:**

- If the glass is dirty or any foreign objects are stuck to the glass, calibration may not be operated properly. Keep the glass clean.
- Interrupt copying is not available during calibration.

# 1. AUTOMATIC CALIBRATION (Cont.)

9 When the message “Scanning and calibrating” disappears, press the **TEST PRINT** key to print out the second test chart.

10 Press the **CALIBRATION** key, then set the printed out chart on the glass in the same way as the first calibration.

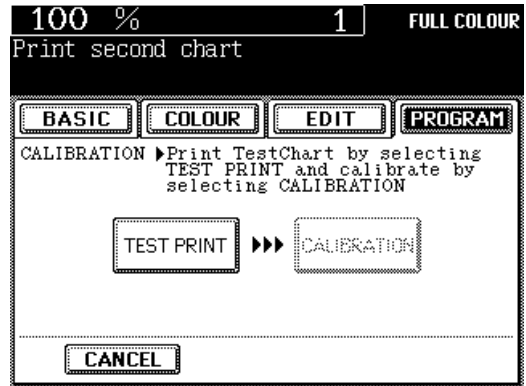

11 Press the **START** key to start the second calibration.

12 When the message “Scanning and calibrating” goes out, all the operation is completed.

**Tip:** If you want to return the image quality level to the default setting after the calibration, press the **DEFAULT** key in step 4.

## 2. SETTING THE DATE AND TIME

With the digital keys, dates and times of the copier's internal clock can easily be set consistent with the current date and time.

- 1 Press the **PROGRAM** key to enter the Programme menu. Press the **Next** key and then the **DATE/TIME** key.

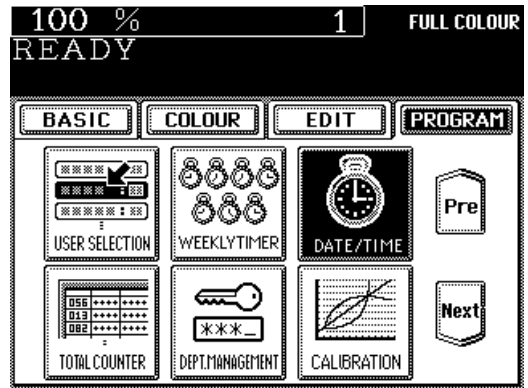

- 2 Key in the last two numbers of the year and press **→**.

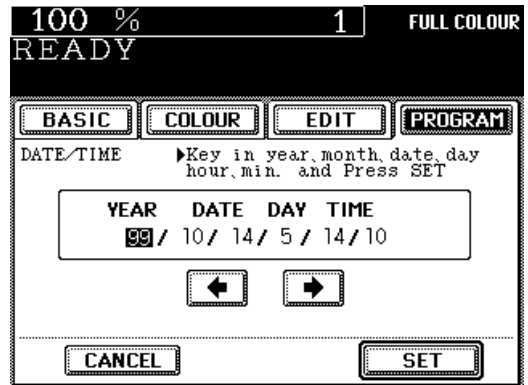

Example: 1999 → 9 + 9 + **→**  
2003 → 0 + 3 + **→**



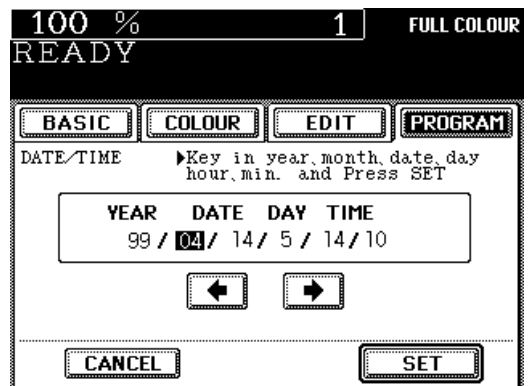

- 3 Key in the month (1~12) and press **→**.  
Example: April → 0 + 4 + **→**



## 2. SETTING THE DATE AND TIME (Cont.)

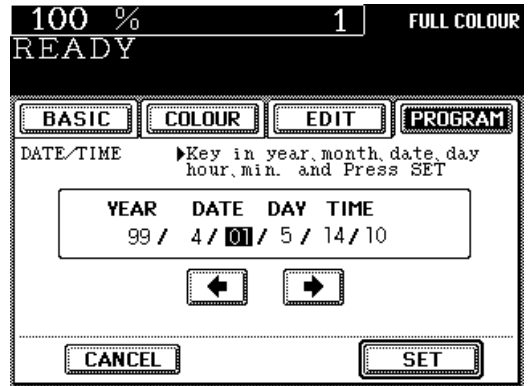

- 4** Key in the date (1~31) and press .  
 Example: 1st, April → 0 + 1 + 

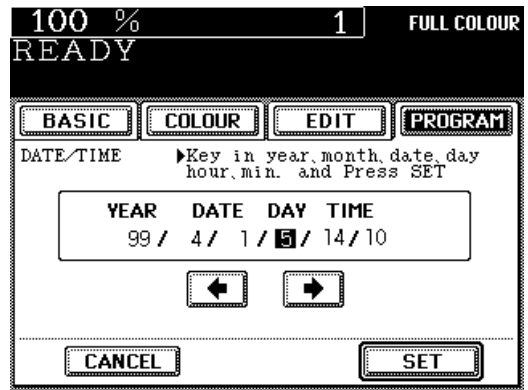

- 5** Key in the number corresponding to the day of the week (1: Sun., 2: Mon. ~7: Sat.) and press .  
 Example: Thu. → 5 + 

Number	1	2	3	4	5	6	7
Day	Sun.	Mon.	Tue.	Wed.	Thu.	Fri.	Sat.



- 6** Key in the hour (0~23) and press .  
 Example: 10 : 30 a.m. → 1 + 0 +   
 • Time is displayed in the 24-hour system.

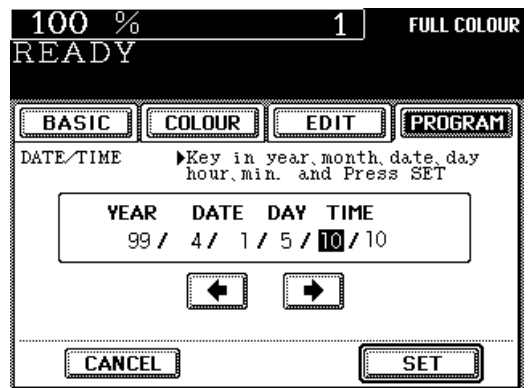

- 7** Key in the minute (0~59).  
 Example: 10 : 30 a.m. → 3 + 0

- 8** Check that all the settings are correct.  
 • If you have noticed an error, first press the  key and then enter the correct number.

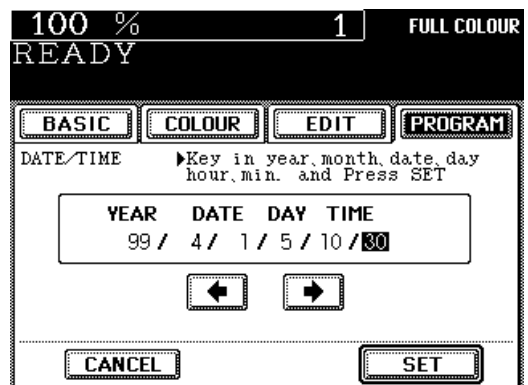

- 9** Press the **SET** key.  
 • The date/time setting screen is cleared.

# 3. WEEKLY TIMER

The weekly timer, which is incorporated in the copier, is a feature for turning ON and OFF the copier automatically at the desired times specified. If you set the timer for the start time in the morning and the end time in the evening of your office, the copier will automatically turn itself ON and OFF at the specified times to meet the schedule of your office.

\* To allow the weekly timer to work properly, the power switch should be always left ON.

## Setting the Weekly Timer

**1** Press the **PROGRAM** key to enter the Programme menu. Press the **Next** key and then the **WEEKLY TIMER** key.

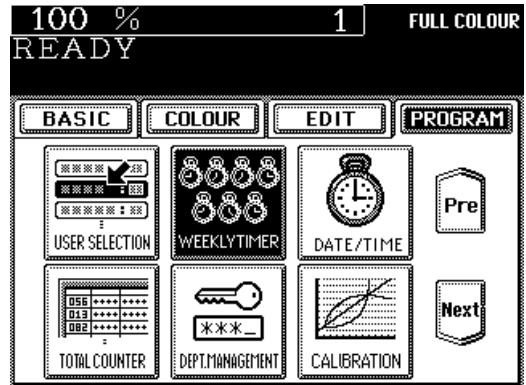

**2** Check the settings. If they are OK, press the **SET** key. To change the settings, press the **CHANGE** key.

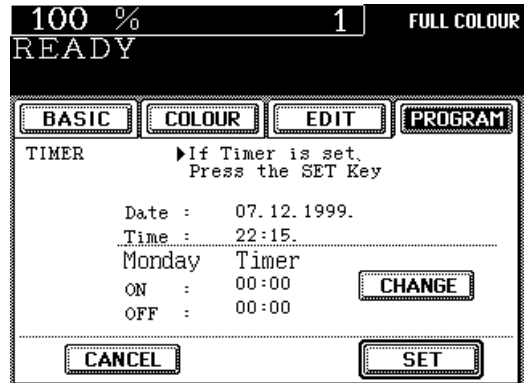

**3** Set the ON/OFF times for each day of the week.

- Switch the day of the week by using the **◀ Sun** and **Sat ▶** keys.
- Set the ON/OFF times by using the digital keys.
- If the settings for each day of the week are OK, press the lower **SET** key.
- For holidays for which the copier should not be turned on, set the time as follows:  
 ON : 00:00  
 OFF : 00:00

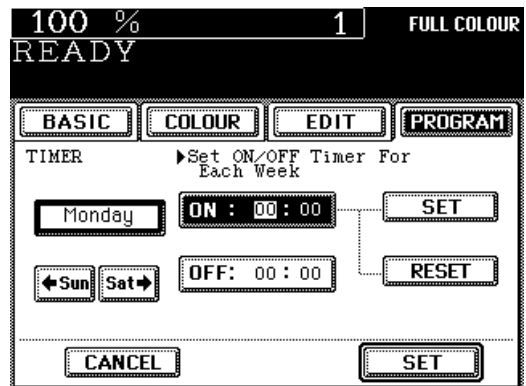

USING THE SPECIAL FUNCTIONS

# 3. WEEKLY TIMER (Cont.)

## cancelling Operation of the Weekly Timer

You can cancel operation of the weekly timer so that the copier can be turned ON and OFF as normal by the power switch.

**1** Press the **PROGRAM** key to enter the Programme menu and press the **Next** key.

- The menu on the right appears.

**2** Check that the **WEEKLY TIMER** key is shaded. Then press the **WEEKLY TIMER** key to return the display to normal. This turns the weekly timer **OFF**.

**Tip:** Weekly timer ON/OFF settings are held in the memory unless they are changed. The stored settings can easily be restored when the operation of the weekly timer is resumed.

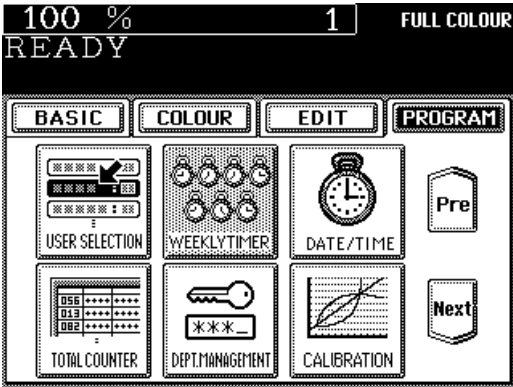



# 4. MODE MEMORY

You can store and recall a combination of frequently used copy modes at any time you like. In addition to reproduction ratios, you can also store image density levels and copy quantities, colour adjustment modes, editing modes and duplex copying modes. You can register up to four combinations.

## Storing a New Combination of Copy Modes

### 1 Set the desired copy modes.

#### Example 1:

Reproduction ratio .... 85%  
Copy quantity ..... 10  
Image density ..... Full colour  
Copy size ..... A4-R

#### Example 2:

Colour balance ..... Y(Yellow)+1, M(Magenta)+2  
C(Cyan)-1, K(Black)0  
Copy size ..... A4-R  
Reproduction ratio .... 90%

- You can check that each mode is correctly set by pressing the **SETTINGS** key.

### 2 Press the **PROGRAM** key to enter the Programme menu, and then press the **MODE MEMORY** key.

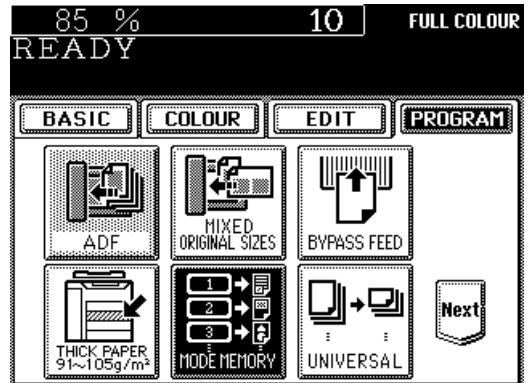

USING THE SPECIAL FUNCTIONS

### 3 Press the **MEMORY** key.

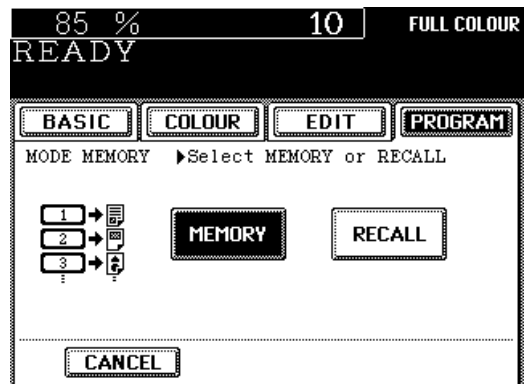

# 4. MODE MEMORY (Cont.)

**4** Press the **MEMORY1** (or, **MEMORY2**, **MEMORY3**, **MEMORY4**) key.

- The combination of copy modes is stored in mode memory 1 (or, 2, 3, 4)
- Stored combinations of copy modes remain until new ones are entered. They are not erased even when the power switch is turned OFF.

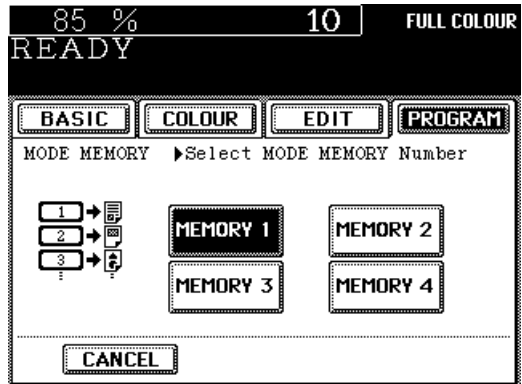

## Recalling a Stored Combination of Copy Modes

**1** Press the **PROGRAM** key to enter the Programme menu, and then press the **MODE MEMORY** key.

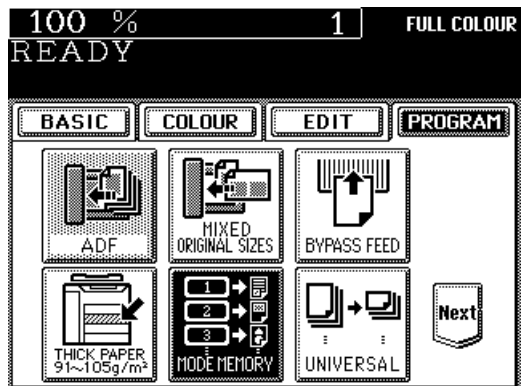

**2** Press the **RECALL** key.

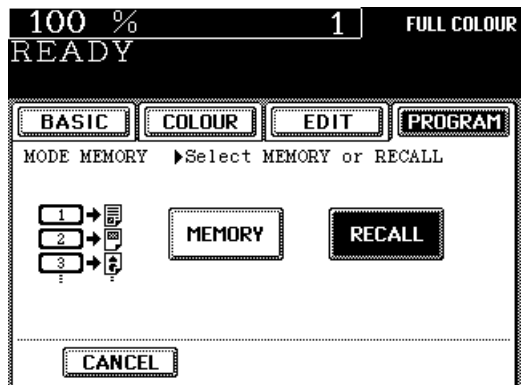

**3** Press the key for the combination of copy modes you want to recall.

**4** Press the **START** key. The original is copied in the combination of modes you have recalled.

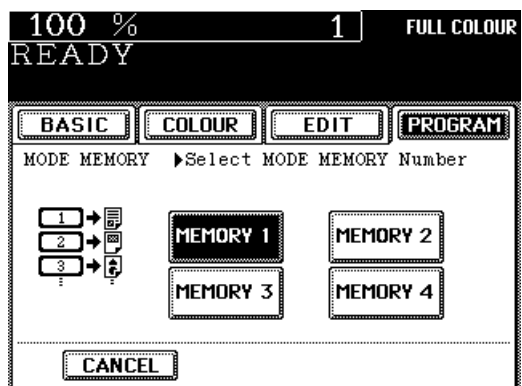

# 5. COPYING USING PAPER OF UNIVERSAL SIZES

If you set the paper of non-European sizes such as US standard sizes (Ledger-Statement) in the cassette for "UNIVERSAL" size, the copier automatically calculates the reproduction ratio by the Automatic Magnification Selection mode. And the reproduction ratio of the originals within the dimensions shown on the right can automatically be selected for the standard size by keying in the paper size.

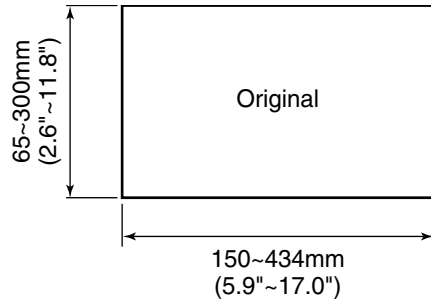

## Making US Standard Size Copies

**1** Press the **PROGRAM** key to enter the Programme menu.

**2** Press the **UNIVERSAL** key.

**3** Press the **STANDARD** key.

**4** Press the desired size key for UNIVERSAL size.

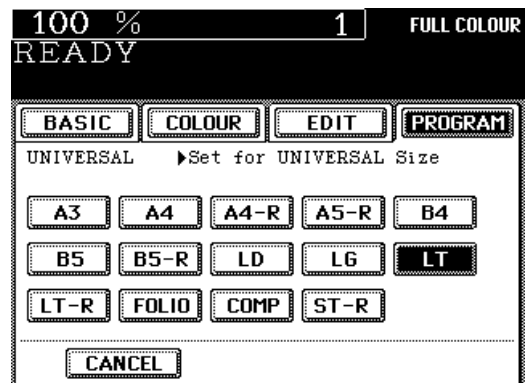
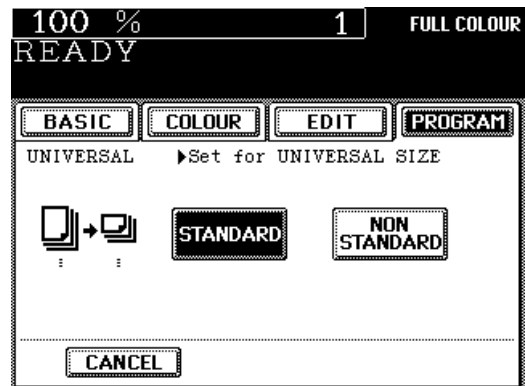
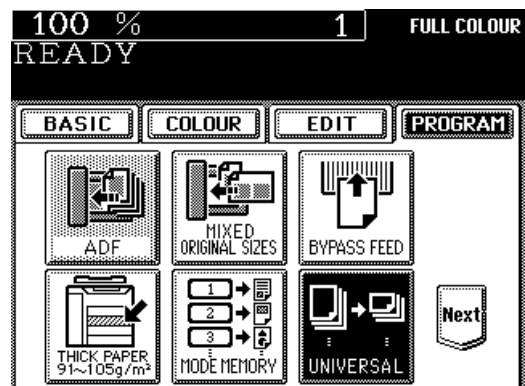

USING THE SPECIAL FUNCTIONS

# 5. COPYING USING PAPER OF UNIVERSAL SIZES (Cont.)

**5** To change to a US standard size, reset the size mark plate so that the **UNIVERSAL** mark appears and set the corresponding size of paper (see page 133).

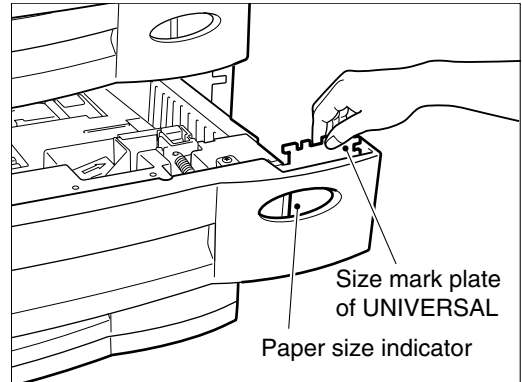

**6** Press the **BASIC** key to return to the Basic menu, then make sure that the "UNIV" is shown on the paper size indicator of the corresponding cassette.

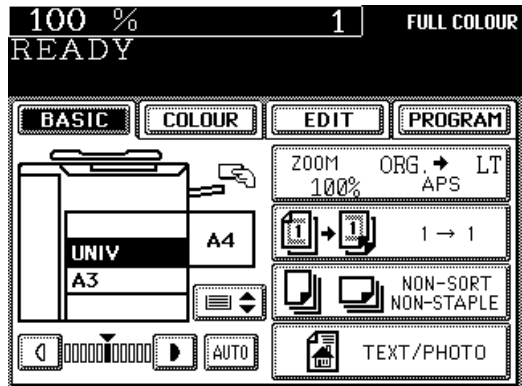

**7** Press the **ZOOM ORG. → LT** key to display the original size selection screen.

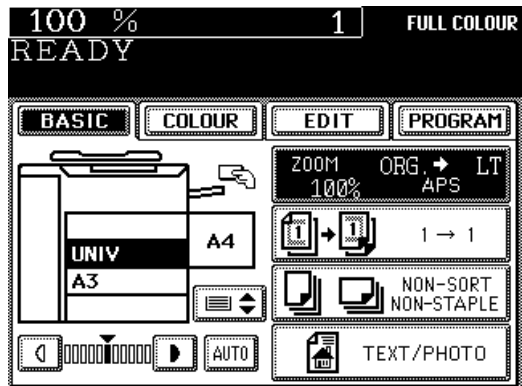

**8** Press the **UNIV** key of the ORIGINAL on the screen to make copies of UNIVERSAL size of originals. Press the **UNIV** key of COPY on the screen if you make copies on the UNIVERSAL size paper.

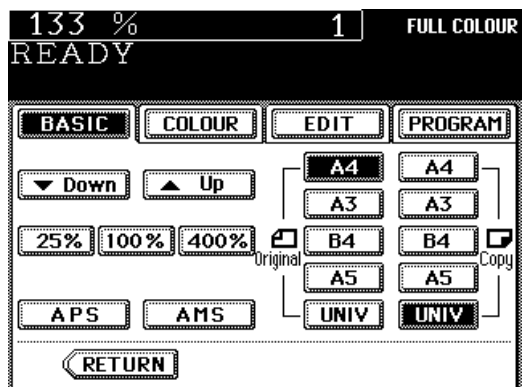

- 9 After you have set the originals, select the copy quantity, etc. if necessary, and press the **START** key.

**Tip:** FOLIO is the default size of the UNIVERSAL size.

## Making Copies of Non-Standard Originals

- 1 Press the **PROGRAM** key to enter the Programme menu.

- 2 Press the **UNIVERSAL** key.

- 3 Press the **NON STANDARD** key.

- 4 Key in the dimensions (length, width) of the original set for the UNIVERSAL size, then press the upper **SET** key.

- 5 If the keyed-in dimensions are correct, press the lower **SET** key.

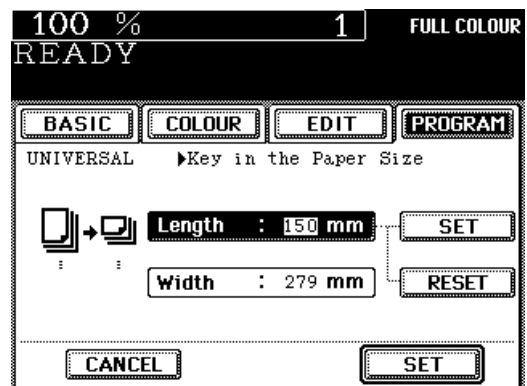
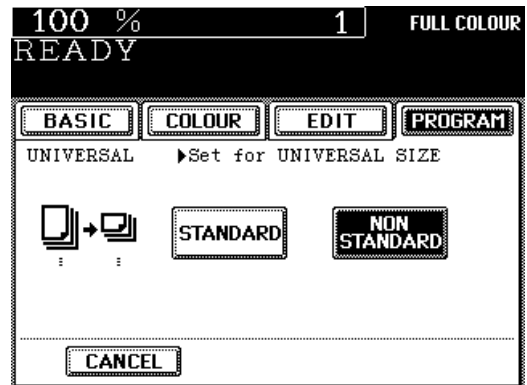
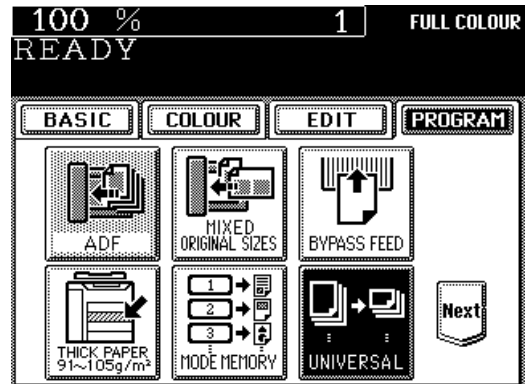

# 5. COPYING USING PAPER OF UNIVERSAL SIZES (Cont.)

6 Press the **BASIC** key to enter the Basic menu, then press the **ZOOM ORG. → A4** key.

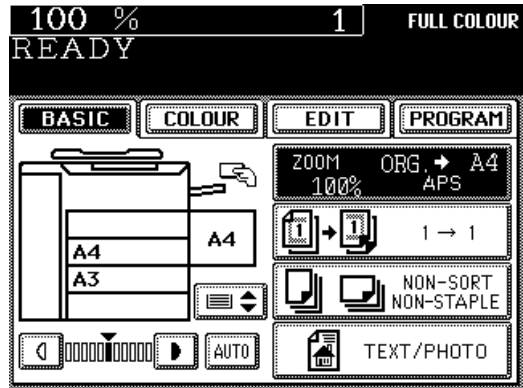

7 Press the **UNIV** key of the ORIGINAL on the screen.

8 After you have set the originals, select the copy quantity, etc. if necessary, and press the **START** key.

**Notes:**

- Non-standard size paper cannot be set.
- Only one size can be set for the UNIVERSAL size. You cannot set Standard size and Non-standard size at a time.

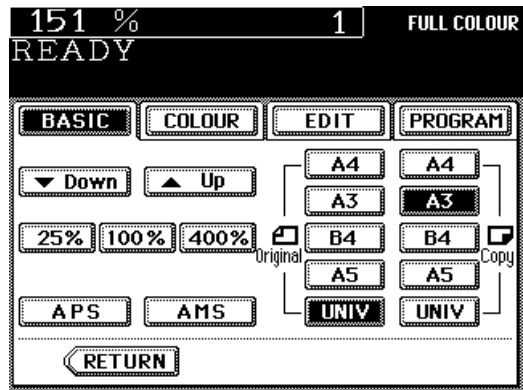

# 6. ACCESS CODES (ID NUMBERS)

If the copier is set up so that access codes can be used, you can make copies only after entering the access code. When making copies using access codes, the copy quantity is stored for each access code used.

See page 114 for how to register, change, or clear the access code.

**1** If the Department Management function is activated, the screen on the right is displayed when the power switch is turned ON or the automatic function clear mode (page 14) is operated.

**2** Key in a registered access code (4 digits) to make the copy available.

**Notes:**

- Available 4-digit numbers are between 0001 and 9999.
- If the message "Enter job access code" still appears and the screen does not change, the keyed-in access code may be wrong. Key in the correct number.
- When you are using the Department management function, press the ACCESS  key on the control panel after you have finished using the copier.

The display changes to the access code input screen, and Department Management function is continuously available.

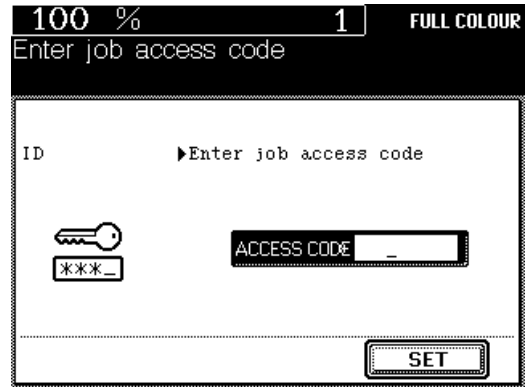

# 7. TOTAL COUNTER

This function displays the total number of copies or number of prints.

**1** Press the **PROGRAM** key to enter the Programme menu and press the **Next** key.

**2** Press the **TOTAL COUNTER** key.

- The total number of copies or prints of the copier is displayed classified by the color mode.

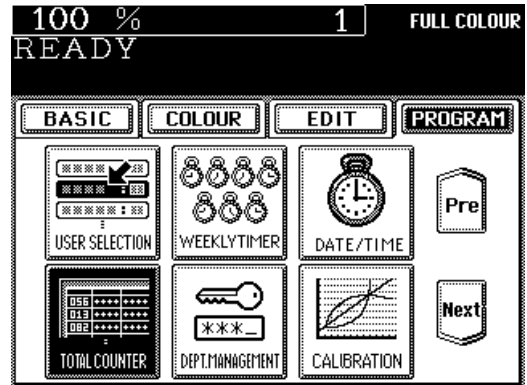

The screenshot shows the copier's control panel displaying the TOTAL COUNTER screen with the following table:

	FULL COLOUR	MONOCOLOUR	BLACK	TOTAL
COPY	1056	10	47	1113
PRINT	800	0	23	823
TOTAL	1856	10	70	1936

Below the table is a **RETURN** button.

**Tip:** The total counter is an add-up counter. You cannot clear the number of the counter.



# 8. DEPARTMENT MANAGEMENT

This function allows you to administer the copy quantity of each department by setting an access code for each department. Up to 120 codes can be set.

\* This function requires keying in the password of the key operator.

**1** Press the **PROGRAM** key to enter the Programme menu, and press the **Next** key then the **DEPT.MANAGEMENT** key.

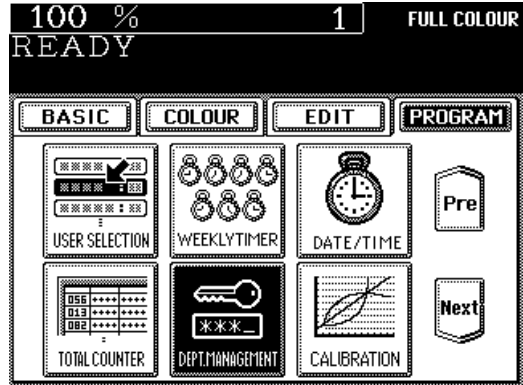

**2** Enter the password of the administrator (key operator).

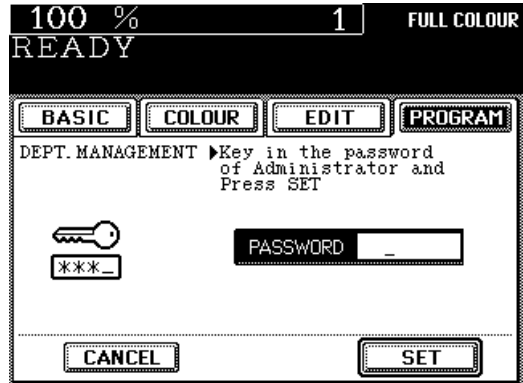

- The department management screen appears.

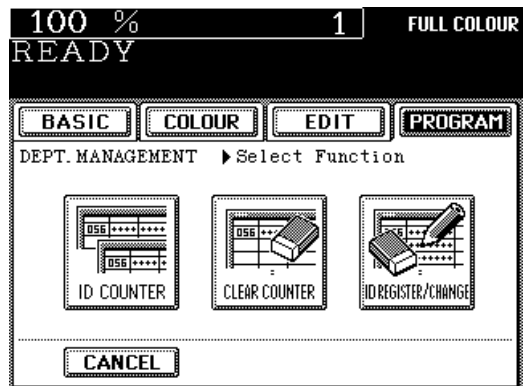

USING THE SPECIAL FUNCTIONS

# 8. DEPARTMENT MANAGEMENT (Cont.)

## ID Counter

This function displays the number of copies output for each department (or access code) classified according to colour mode.

- 1 Press the **ID COUNTER** key in the Department Management menu.

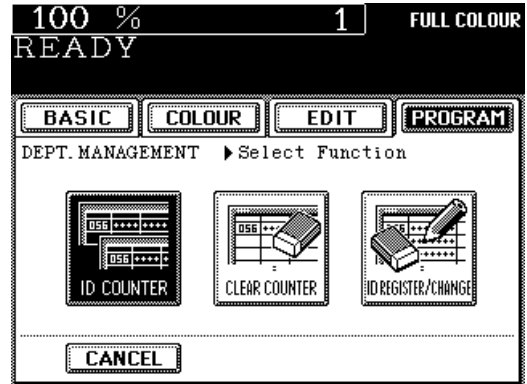

- 2 If you want to check the counters of all access codes, press the **ALL** key.
  - The total copy quantity of each access code is displayed.

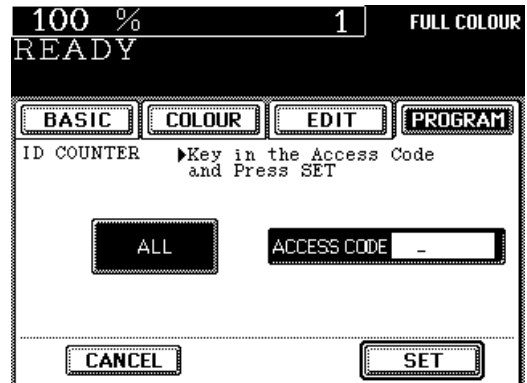

- 3 If you want to check the counter of a certain department, enter its access code (4 digits) and press the **SET** key.
  - The total copy quantity of the corresponding access code is displayed in the frame.

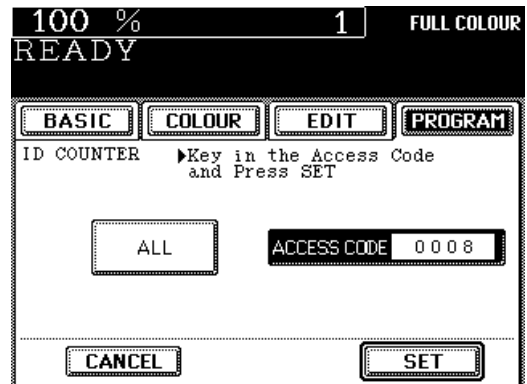

- 4 access codes can be displayed at a time. Press the **NEXT** or **PREV** key to switch the screen for other access codes.
- Access codes are displayed in numerical order (up to 120 codes).

100 %		1		FULL COLOUR	
READY					
BASIC		COLOUR		EDIT	
				PROGRAM	
ID COUNTER					
CODE	FULL COLOUR	MONOCOLOUR	BLACK	TOTAL	
0006	80	2	6	88	
0008	26	0	4	30	
0047	67	0	0	67	
0056	13	6	2	21	

RETURN

PREV NEXT

# 8. DEPARTMENT MANAGEMENT (Cont.)

## Clearing Counters

This function clears a certain department (access code) or all departments to "0".

- 1 Press the **CLEAR COUNTER** key in the Department Management menu.

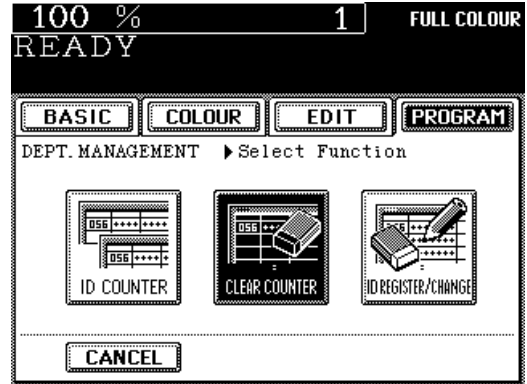

- 2 If you want to clear the counters of all the access codes, press the **ALL** key.

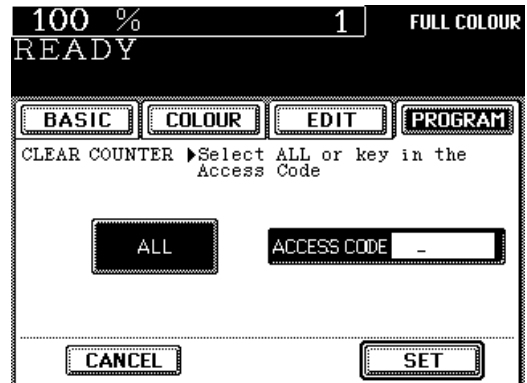

- 3 If you want to clear the counter of a certain department, enter its access code (4 digits) and press the **SET** key.

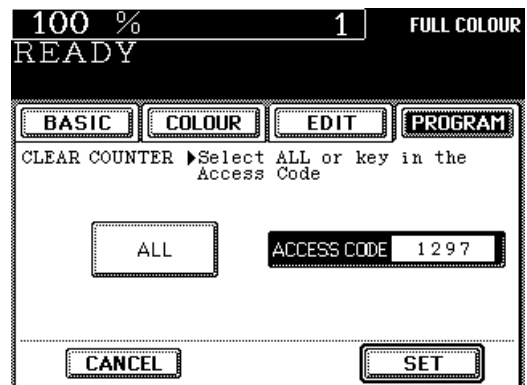

4

Press the **YES** key.

- The counter is cleared and the number becomes "0".

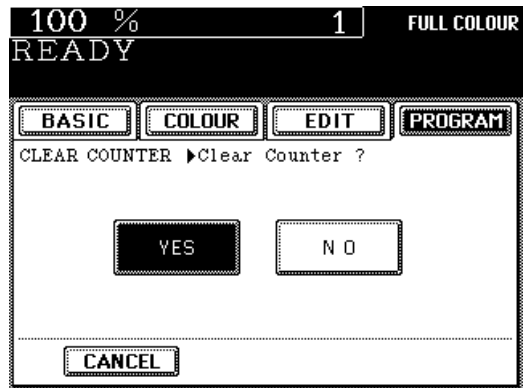

# 8. DEPARTMENT MANAGEMENT (Cont.)

## Registration/Change/Deletion of Access Codes

This function registers, changes and deletes the access codes.

### Registering a new department

1 Press the **ID REGISTER/CHANGE** key in the Department Management menu.

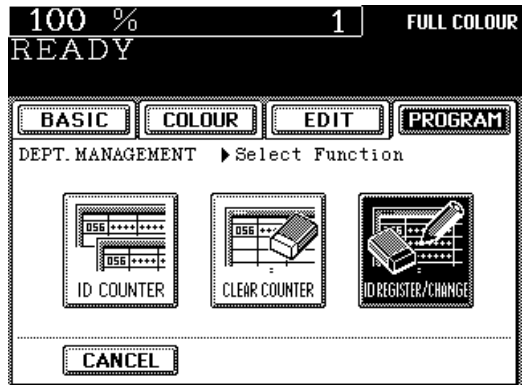

2 Press the **REGISTRATION** key.

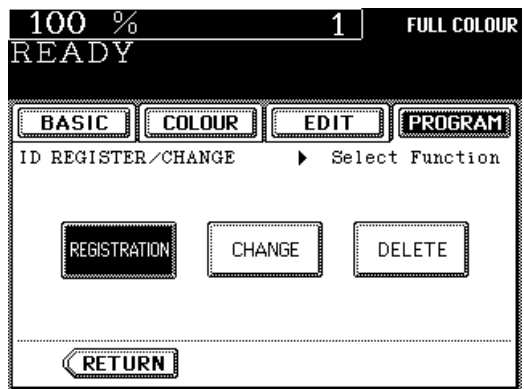

3 Using the digital keys, enter the access code (4 digits) you want to register both for **NEW ACCESS CODE** and for **CONFIRM ACCESS CODE**.

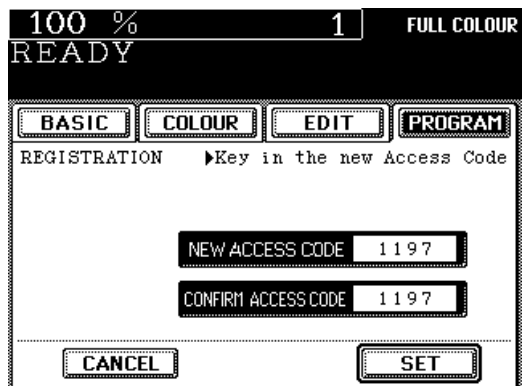

4 Press the **SET** key.

## Changing the access code of a certain department

- 1 Press the **ID REGISTER/CHANGE** key in the Department Management menu.

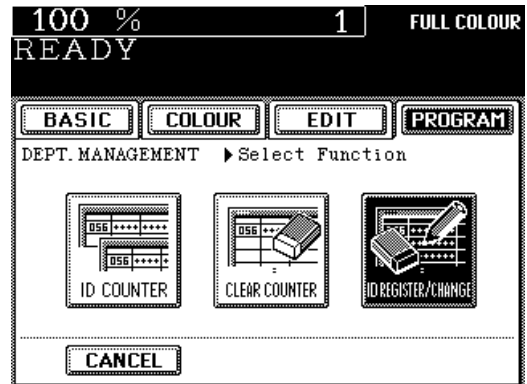

- 2 Press the **CHANGE** key.

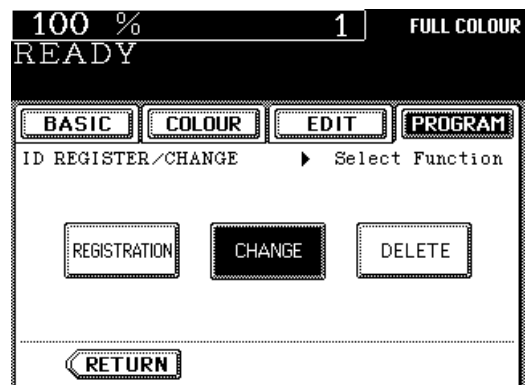

- 3 Using the digital keys, enter the access code (4 digits) you want to change, then press the **SET** key.

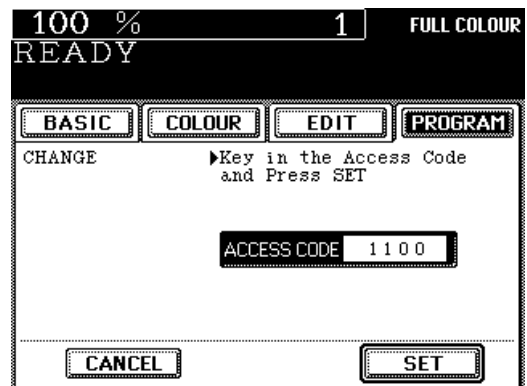

- 4 Using the digital keys, enter the access code (4 digits) you want to register both for **NEW ACCESS CODE** and for **CONFIRM ACCESS CODE**.

- 5 Press the **SET** key.

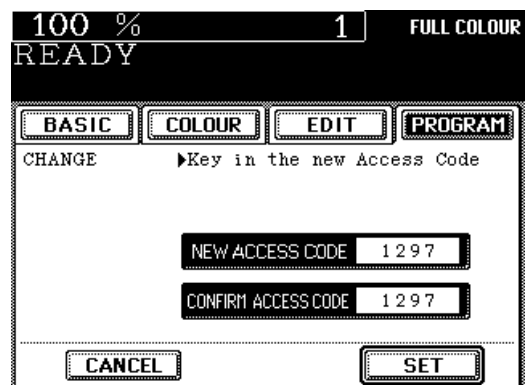

# 8. DEPARTMENT MANAGEMENT (Cont.)

## Deleting a department from the department management

1 Press the **ID REGISTER/CHANGE** key in the Department Management menu.

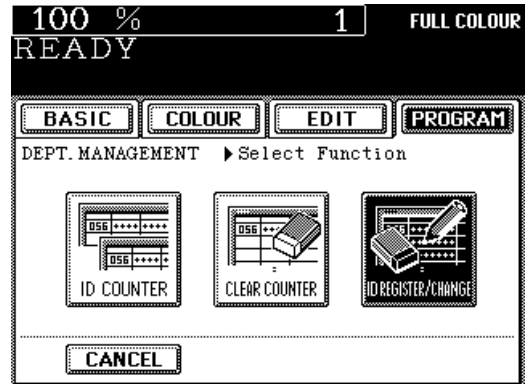

2 Press the **DELETE** key.

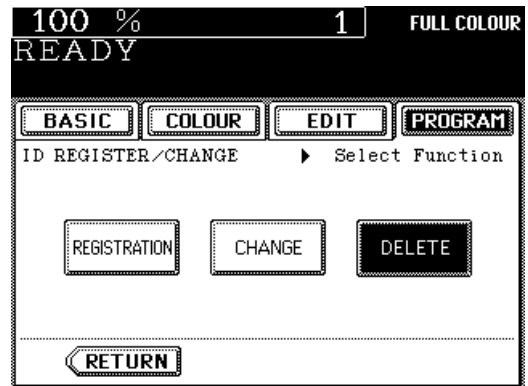

3 Using the digital keys, enter the access code (4 digits) you want to delete, then press the **SET** key.

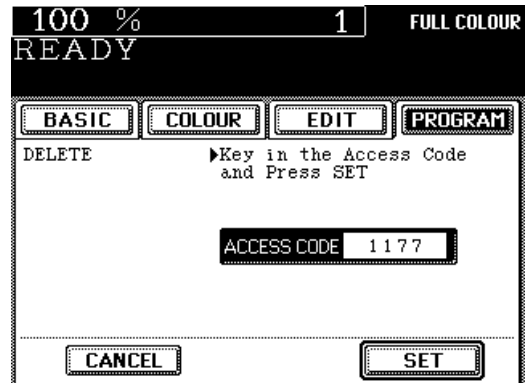

4 Press the **YES** key.

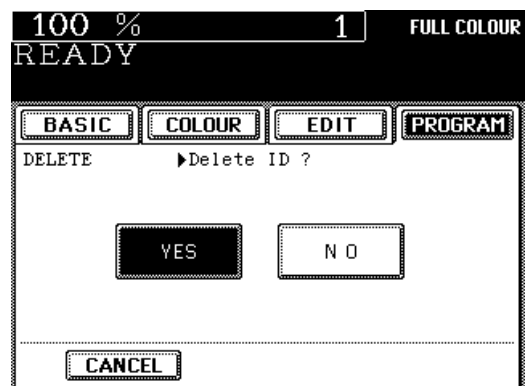



# 9. KEY COPY COUNTER

When the copier is set up so that key copy counters can be used, you can make copies only by inserting your key copy counter, and the copies made are recorded (added) in the key copy counter. You can use any number of key copy counters.

**Note:** For details on how to use a key copy counter, consult a service technician.

## Procedure

- 1 The following message appears:**  
Set key copy counter

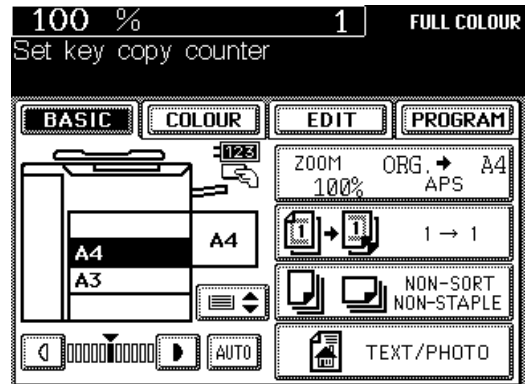

- 2 Insert the key copy counter.**
  - Hold the counter so that the surface with an arrow faces upward with the arrow pointed toward the copier. Then insert it slowly until it comes to a stop.
- 3 The following message appears:**  
READY
  - Make copies as you would normally do.
- 4 When you have finished making copies, remove your key copy counter.**

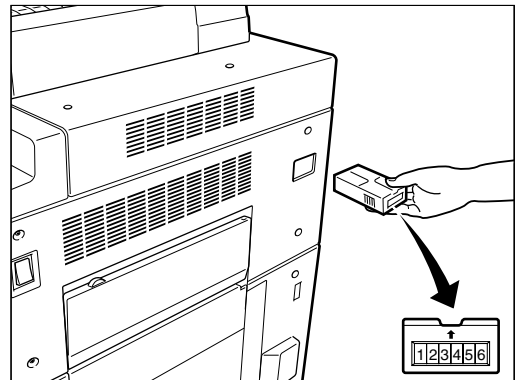

# 10. CHANGE OF LANGUAGE ON THE DISPLAY PANEL

You can change the language on the display panel.

- 1 Press the **PROGRAM** key to enter the Programme menu, press the **Next** key twice to display the panel on the right, then press the **CHANGE LANGUAGES** key.



- 2 Press one of the other languages.

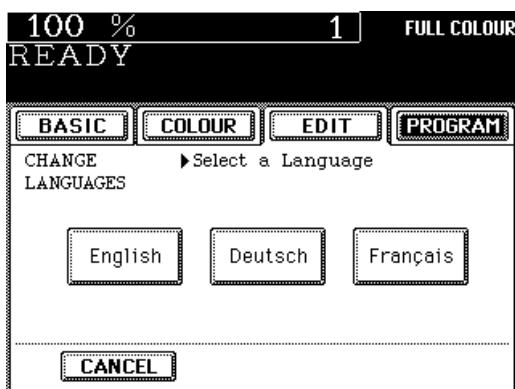

# 11. USER SELECTION (INITIAL SETTINGS)

This function allows you to change the initial setting (default setting) of each mode displayed when the power is turned ON, when the Energy-Saving mode is cancelled, or when the FUNCTION CLEAR key is pressed.

**1** Press the **PROGRAM** key to enter the Programme menu, then press the **Next** key.

**2** Press the **USER SELECTION** key.

**3** Press the desired key for which you want to change the initial setting.

- You can switch the screen by pressing the **Next** or **Pre** key.

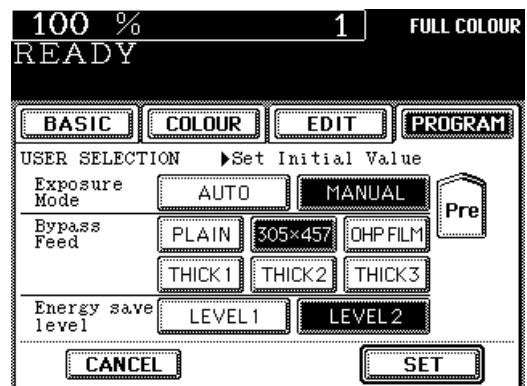
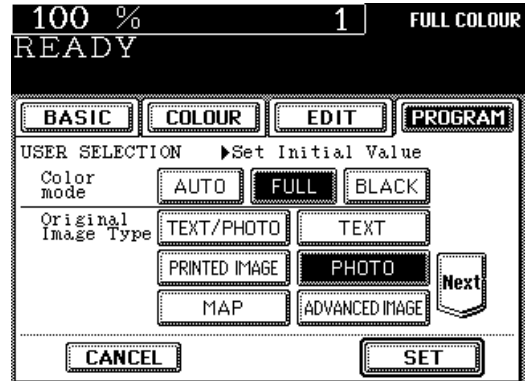
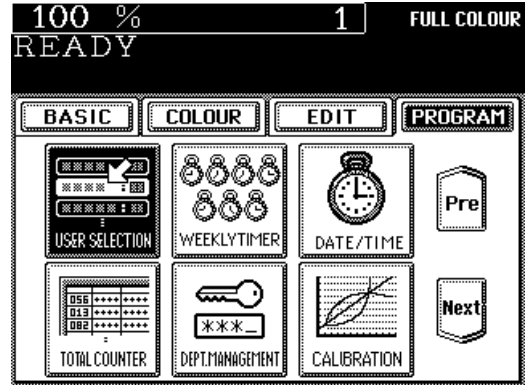

**4** Press the **SET** key.

USING THE SPECIAL FUNCTIONS



# 6. USING THE OPTIONAL STAPLE SORTER

1. Description of the Main Components . . . . .	122
2. Non-sort Copying . . . . .	123
3. Sort or Staple Sort Copying . . . . .	124
4. Group Copying . . . . .	128

# 1. DESCRIPTION OF THE MAIN COMPONENTS

When the optional staple sorter MG-2014 is attached to the copier, you can select the sort, group or staple mode. Non-sort is automatically selected as the default mode.

## Non-sort bin

In the non-sort mode, copies exit into this bin. However, they will also go into the sort bins when more than 250 sheets are copied or depending upon the size of paper selected.

## Sort bins (Bins "1" ~ "20")

In the sort or group mode, all copies exit into these bins. However, when more than 250 copies are set in the non-sort mode, some of them will also enter these bins.

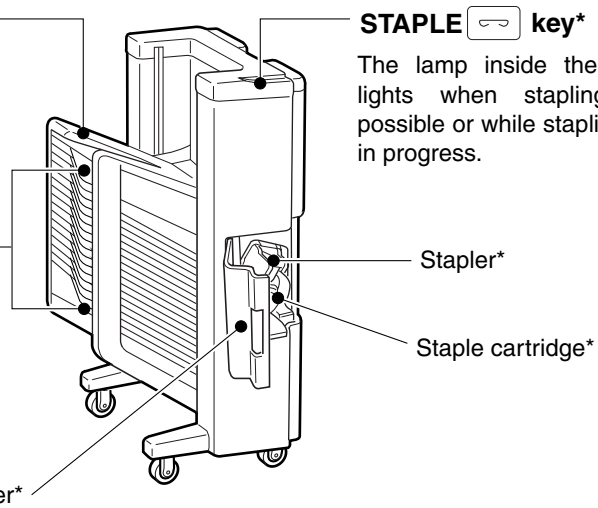

## STAPLE key\*

The lamp inside the key lights when stapling is possible or while stapling is in progress.

**Note:** See page 162 for the details of the staple sorter specification.

## 2. NON-SORT COPYING

**1** Check that **NON-SORT, NON-STAPLE** is displayed on the Basic menu.

- If **Sort**, **Group** or **Staple Sort** is displayed, press the key and select **NON-SORT, NON-STAPLE**.

**2** Place the original(s) on the original feed tray or on the glass.

- See page 22 for how to set the original.

**3** Key in the desired copy quantity.

- When 250 or less is copied at a time, all the copies will exit into the non-sort bin. When you use the optional automatic document feeder, the total number of copies (the number of originals X copy quantity) should be 250 or less.
- When more than 250 is copied at a time, the specified number of copies will exit into sort bins "1" up to "20", then the remaining copies will exit into the non-sort bin.
- If more than 850 (A4) or 750 (A3/B4/A4-R) is copied at a time, the copier automatically stops when 850 (or 750) copies have been completed, and the following message appears:

Remove paper from sorter bins

Remove all the copies from the staple sorter and press the START key again to continue.

**4** Select the desired copy size, reproduction ratio, image density level, etc. if necessary.

**5** Press the START key.

**Note:** When the staple sorter is working, do not touch the bins.

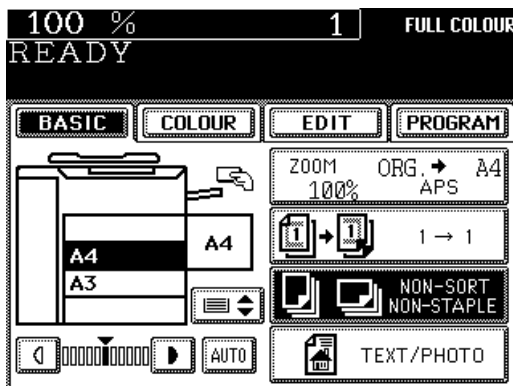

Paper size	Sort bins	Non-sort bin	Total
A4	1st-600th copy (30 copies/bin)	601st-850th copy	850 copies
A3, B4 A4-R	1st-500th copy (25 copies/bin)	501st-750th copy	750 copies

# 3. SORT OR STAPLE SORT COPYING

**Example:**

Making 5 sets of copies from 5-page originals.

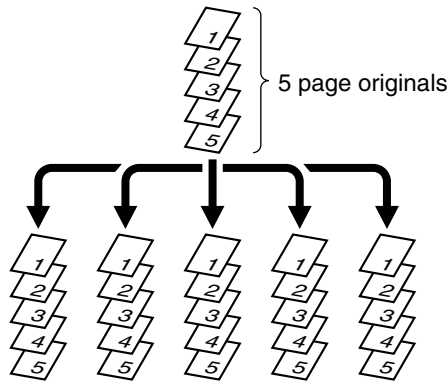

## Sort or Staple Sort

**1** Press the **NON-SORT, NON-STAPLE** key on the Basic menu to enter the Sorter menu.

- To select the SORT mode, press the **SORT** key.

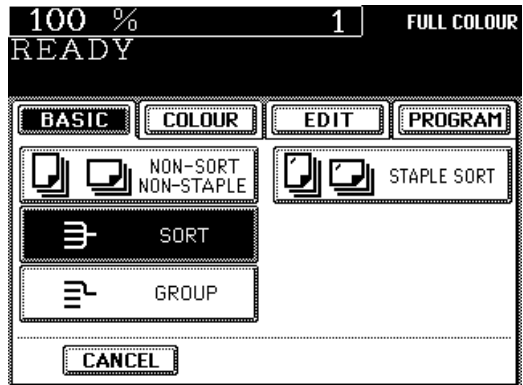

- To select the SORT/STAPLE mode, press the **STAPLE SORT** key.

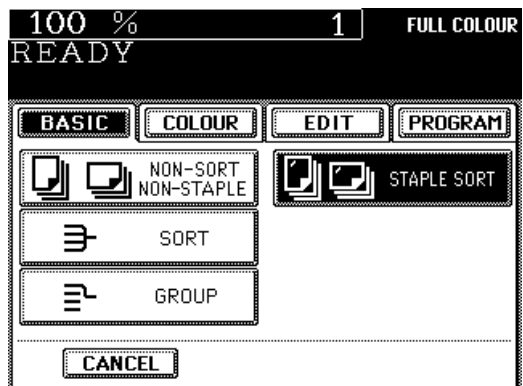



## 2 Place the original(s) on the original feed tray or on the glass.

### Using the automatic document feeder:

Place them with face up and align the side guides to the originals.

Stapling will be done in the position corresponding to the upper left corner of the originals. However, in the 2 in 1 mode, stapling will be done in the position corresponding to the lower right corner (see page 72).

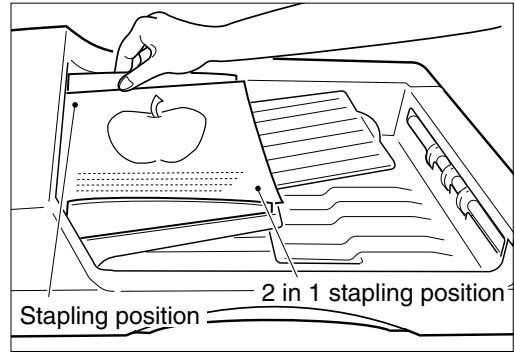

- The number of the originals you can set up at a time is shown below.

Paper Weight	64~80g/m <sup>2</sup>		81~90g/m <sup>2</sup>		91~105g/m <sup>2</sup>	
	Sort	Staple	Sort	Staple	Sort	Staple
A5-R	—	—	—	—	—	—
A4	50	50	40	30	40	20
A3, A4-R, FOLIO	25	25 (50)	25	25 (30)	20	20 (20)

\* ( ) = Manual Stapling

### Placing the originals on the glass:

Place the original face down on the glass. If you start with the last page of your originals, the copies will be arranged in the same page order as the originals.

The copies can be stapled in the position corresponding to the upper right corner of the original.

In this case, however, copies are not stapled automatically (see page 127 for manual stapling).

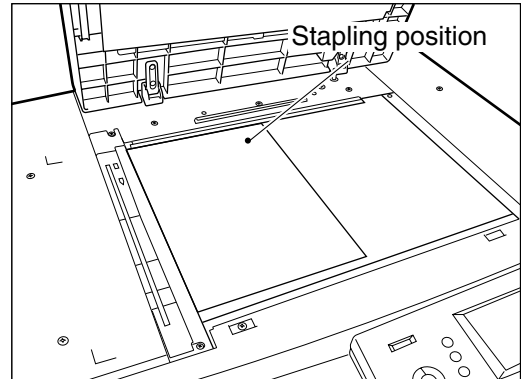

## 3 Key in the number of copies (sets).

Up to 20 sets can be keyed in (all sizes).

## 4 Select the desired copy size, image density level, reproduction ratio, copy quantity, etc. as required.

### 3. SORT OR SORT/STAPLE COPYING (Cont.)

#### 5 Press the START key.

##### Using the automatic document feeder:

- The originals will automatically be fed in one by one.
- If the sort/stapling mode is selected, all the sets of copies will automatically be stapled after copying is finished.
- If the copier stops during the sort or sort/stapling mode and displays



Remove paper from sorter bins ,

remove all the copies from the staple sorter and press the START key again to continue. In this case, stapling is not possible.

##### Placing the original on the glass:

- After the copying of the first original (last page) finishes, place the next original and press the START key.
- Repeat this step until all the originals finish being copied.

#### 6 Pressing the STAPLE key will cause the copies in each bin to be stapled automatically.

- While stapling is in progress, if you press the STAPLE  key again, stapling will stop. Pressing the key again will resume stapling.
- The STAPLE  key lamp comes on only when stapling is possible. However, if the maximum number of copies that can be stapled is exceeded, the STAPLE  key lamp goes out, alerting the operator that stapling is not possible.

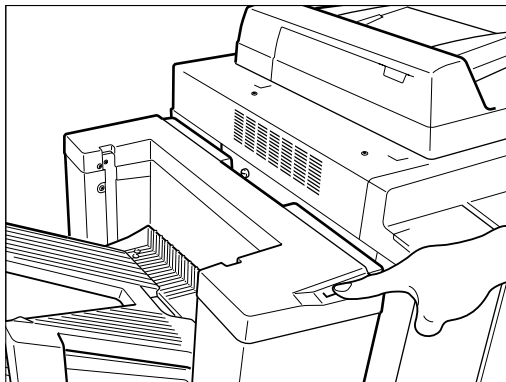

**Note:** Do not open the stapler cover during stapling in order to avoid a staple jam.

## Manual Stapling

### 1 Align the edges of the copies and insert them into the first sort bin.

- The copies should be inserted fully inside and moved to the right and to the front until being stopped.
- The STAPLE  key lamp will come on.
- The maximum number of copies is shown below.
  - 80g/m<sup>2</sup> : 50 (all sizes)
  - 90g/m<sup>2</sup> : 30 (all sizes)
  - 105g/m<sup>2</sup> : 20 (all sizes)

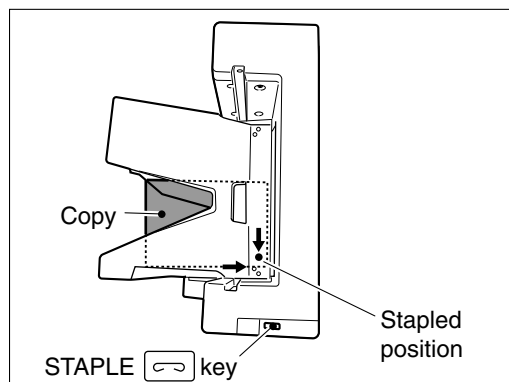

### 2 Press the STAPLE key.

- The copies will be stapled. Repeat steps 1 and 2 for the remaining sets of copies.

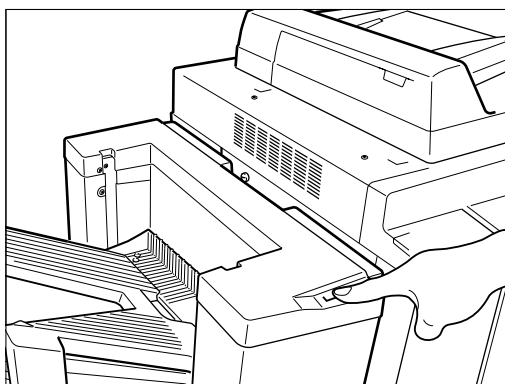

# 4. GROUP COPYING

## Example:

Copying 5 originals in the group mode.

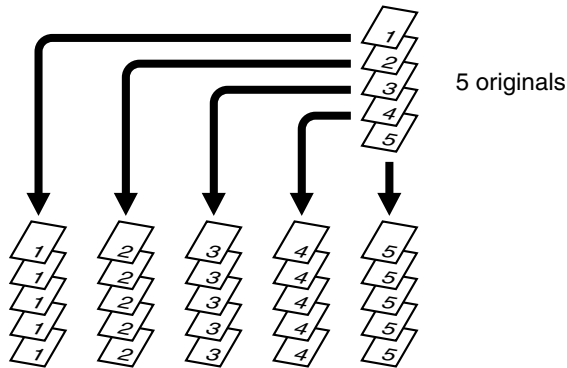

**1** Press the **NON-SORT, NON-STAPLE** key on the Basic menu to enter the Sorter menu.

- Select the **GROUP** key.

**2** Place the original(s) on the original feed tray or on the glass.

- Up to 20 originals (all sizes) can be set at a time.
- See page 22 for how to set the originals.

**3** Key in the number of copies.

- The maximum number of copies that can be set is 30 for A4, or 25 for A3, B4 or A4-R.
- You cannot set a different copy quantity for each original.

**4** Select the desired copy size, image density level, reproduction ratio, copy quantity, etc. as required.

**5** Press the **START** key.

**Using the automatic document feeder:**



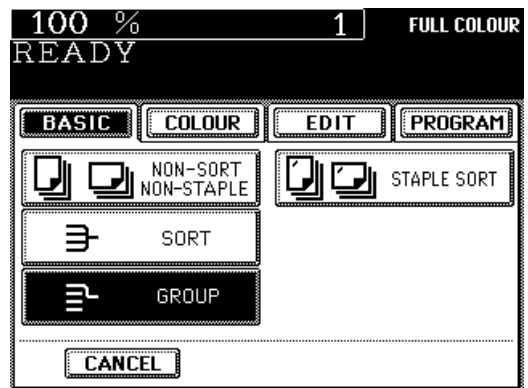

- The originals will automatically be fed in one by one and copied.

**Placing the original on the glass:**

- After the first original finishes being copied, set the next original and press the **START** key.
- The copies of the second original will all exit into the second bin, and those of the third original into the third bin, and so on.



# 7. WHEN THE GRAPHIC SYMBOLS FLASH

1. Add Paper Symbol . . . . .	130
2. Replace Toner Bag  Symbol . . . . .	134
3. Add Toner  Symbol . . . . .	136
4. Clear Paper  Symbol . . . . .	138
① Misfeeding inside of the Copier . . . . .	138
② Misfeeding in the Automatic Duplexer . . . . .	143
③ Misfeeding from the Cassettes . . . . .	145
Misfeeding in the Large-Capacity Feeder . . . . .	146
④ Misfeeding in the Automatic Document Feeder . . . . .	147
⑤ Misfeeding in the Bypass Guide . . . . .	148
⑥ Misfeeding in the Staple Sorter . . . . .	149
5. Replacing Staples . . . . .	150
6. Removing Jammed Staples . . . . .	152
7. Call Service  Symbol . . . . .	154
8. Periodic Maintenance . . . . .	154

# 1. ADD PAPER SYMBOL

When the paper supply in the selected cassette or the optional large-capacity feeder runs out, the cassette or large-capacity feeder symbol on the display panel flashes and this message appears:

Add paper

Add paper as described below.

## Adding Paper to the Front Cassette

- 1 Pull out the cassette slowly until it comes to a stop.

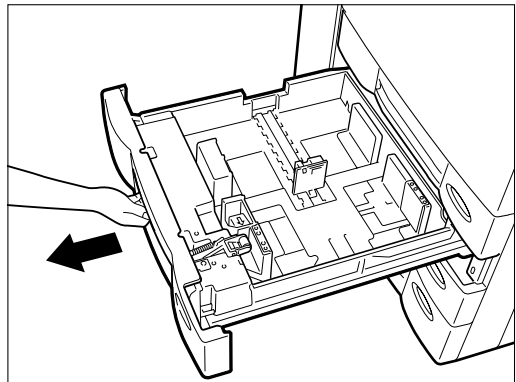

- 2 Place the paper in the cassette.
  - Up to 600 sheets of paper (80g/m<sup>2</sup>) can be set. (See page 18.)
  - Fan the paper well before placing it in the cassette.
  - Do not add paper above the line on the back guide.
  - Do not use creased, folded, wrinkled or damp sheets of paper.

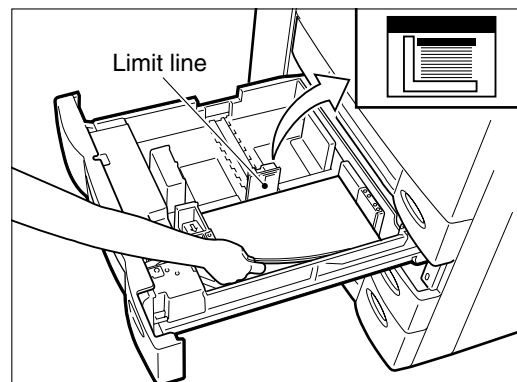

**Note:** Check that there is a slight gap (about 0.5 mm) left between the paper and each of the side guides as shown; the total gap should not exceed 1 mm. If the gap is not suitable, paper misfeeding may possibly occur.

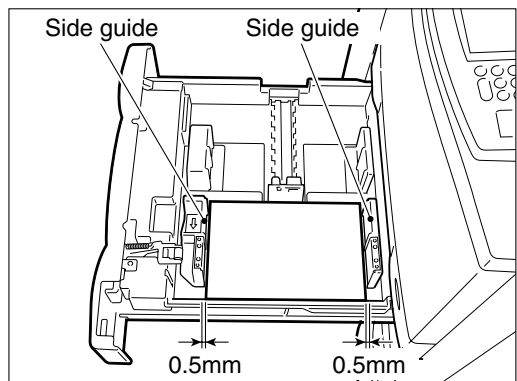

### 3 Push in the cassette straight and slowly until it comes to a stop.

- Make sure that the cassette is pushed in fully.

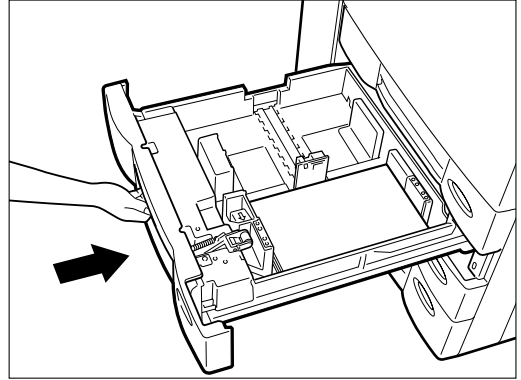

# 1. ADD PAPER SYMBOL (Cont.)

## Adding Paper to the Large-Capacity Feeder (Optional)

- 1** Open the cover of the large-capacity feeder.

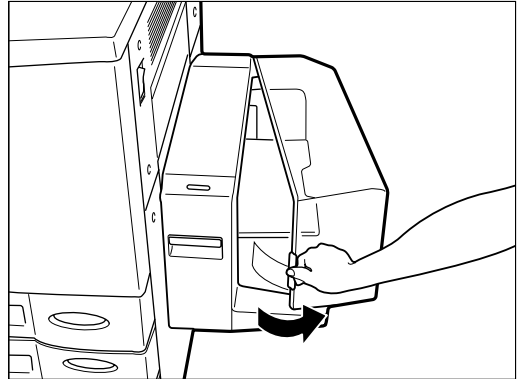

**Note:** If you want to add paper because the paper supply has become low, press the TRAY DOWN  key before opening the cover. The elevator tray will automatically move down and stop.

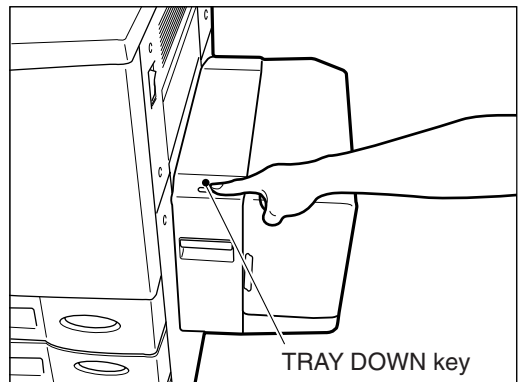

- 2** Place the paper in the large-capacity feeder.

- Make sure that all the sheets are placed neatly aligned against the guide plates at rear side on the elevator tray.
- Up to 1500 sheets of A4-size paper can be placed. Do not add paper above the limit line on the right.
- Do not use creased, folded, wrinkled or damp sheets of paper.

**Tip:** Make sure that there is no gap between the paper set and the guide plates at rear side to avoid image skewing.

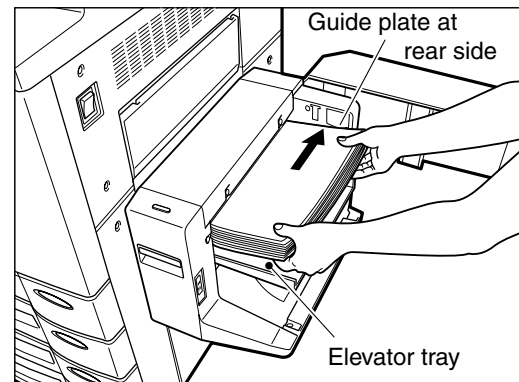

- 3** Close the cover of the large-capacity feeder.
- The elevator tray will automatically move up to the paper feeding position.



## Changing the Paper Size of the Cassette

The paper size of the cassette can be changed to any of A3, B4, A4, A4-R and A5-R. Use the following procedure.

**1 Pull out the cassette slowly and fully.**

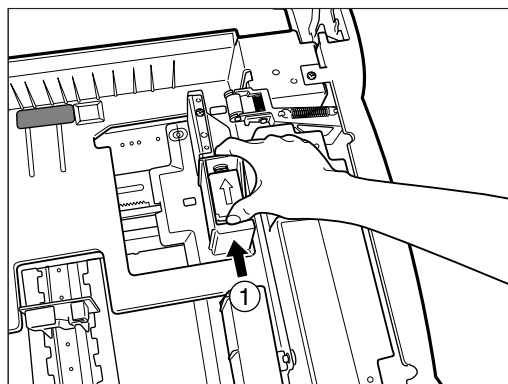

**2 Move the side guides so that the space between them is slightly wider than the desired paper size.**

- To move the side guides, push the lever (arrow ①) to unlock.

**3 Set the back guide to the desired paper size (shown on the cassette surface).**

- To move the back guide, push on its sides (arrows ②) to unlock and slide it with both of your hands.

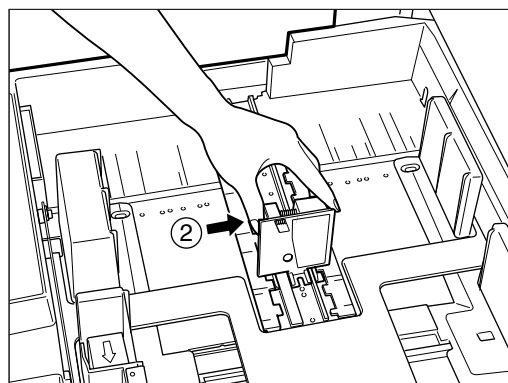

**4 Place paper in the cassette.**

- For placing paper in the cassette, refer to Step 2 in "Adding Paper to the Front Cassette" on page 130.

**5 Remove and reset the size mark plate so that the desired paper size appears.**

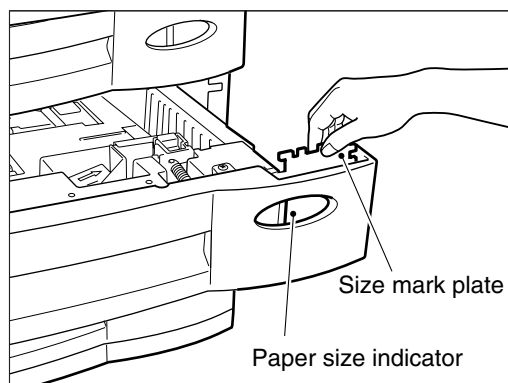

**6 Push in the cassette slowly and fully.**

WHEN THE  
GRAPHIC SYMBOLS  
FLASH

## 2. REPLACE TONER BAG



## SYMBOL

When the toner bag becomes full of used toner, the REPLACE TONER BAG  symbol flashes and this message appears:

Dispose of used toner  
Press INFO

Replace the toner bag as described below.

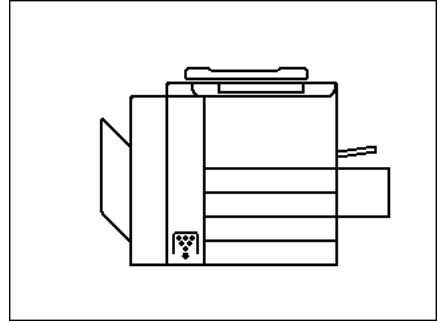

### Replacing Procedure

**1** Open the right-hand front cover.

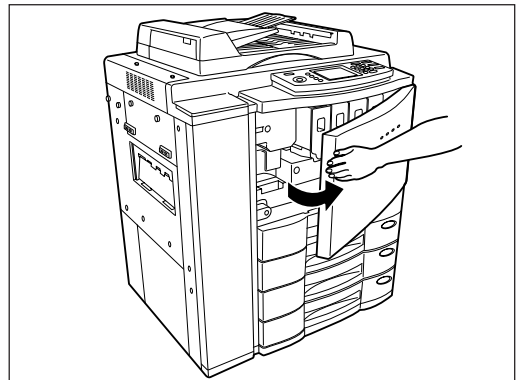

**2** Open the left-hand front cover.

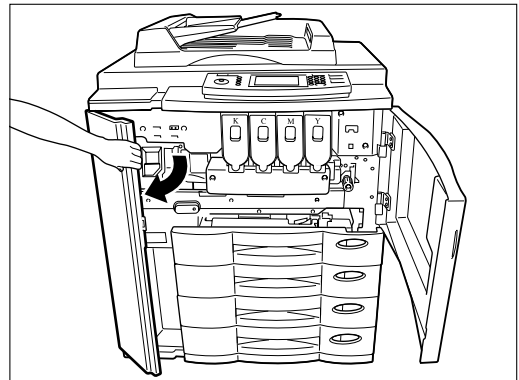

- 3 Remove the used toner bag from the copier.**
- Take out the toner bag in the direction of the arrow.

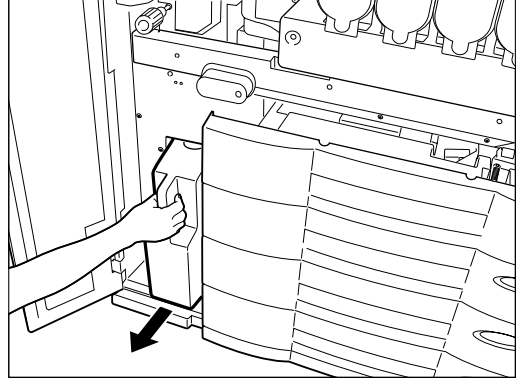

- 4 Close the used toner bag.**
- The cap is provided on the used toner bag.

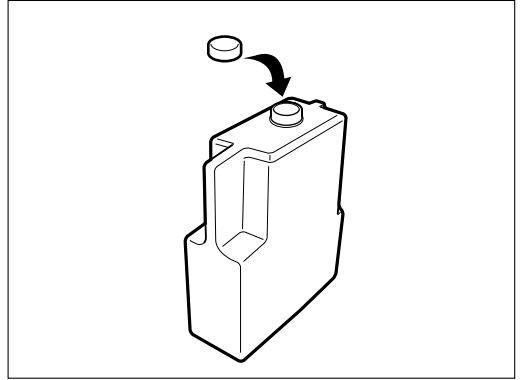

- 5 Set the new toner bag in the copier.**
- Set it in the reverse procedure of step 3.

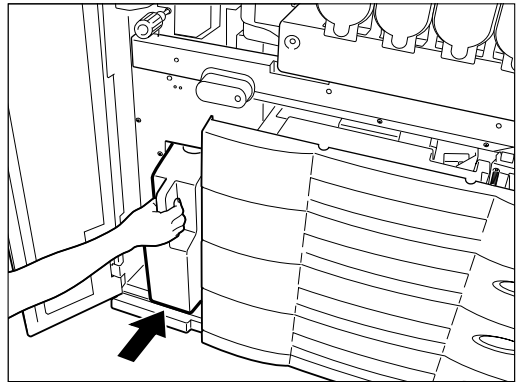

- 6 Close the left-hand front cover.**

- 7 Close the right-hand front cover.**

**Note:** The used toner bag should be disposed of properly.

WHEN THE GRAPHIC SYMBOLS FLASH

# 3. ADD TONER SYMBOL

When the toner supply in a toner cartridge runs out, the ADD TONER  symbol and the symbol that shows the corresponding toner colour flash and then the following message appears on the Basic menu:

Install new Yellow toner cartridge  
Press INFO

Replace the toner cartridge as described below.

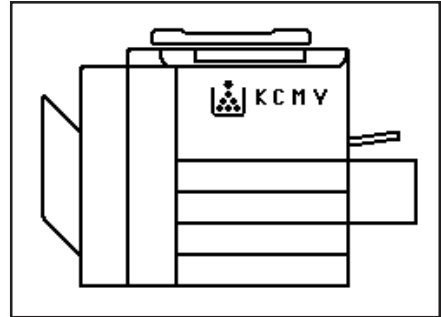

**Note:** It is recommended that only toner cartridge made or designated by Toshiba be used in order to optimize copy quality.



**1** Open the front covers.

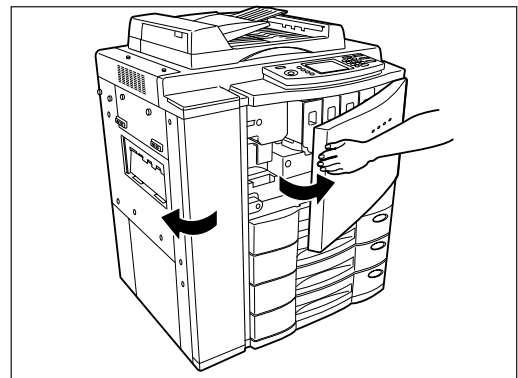

**2** Grasping the holder of the toner cartridge, slide the cartridge along the rail toward you and remove it.

- The empty cartridge should be disposed of properly.

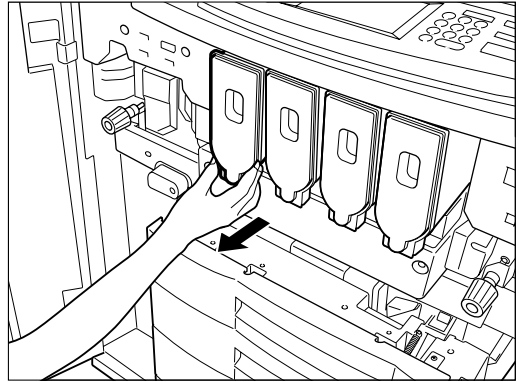

**3** Shake the new cartridge to the right and left 5 or 6 times to loosen the toner inside.

**4** Pull the seal out from the cartridge.

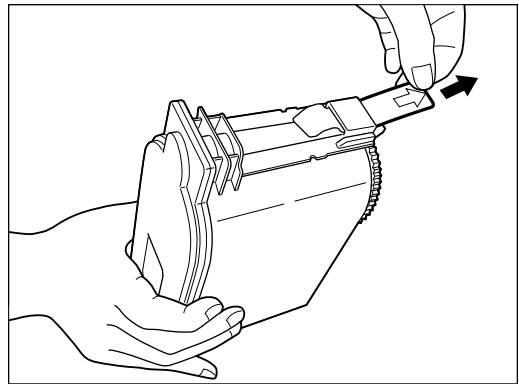

**5** Grasping the holder of the new toner cartridge, push it along the rail fully back into the copier.

- If the toner scatters, wipe it completely off.

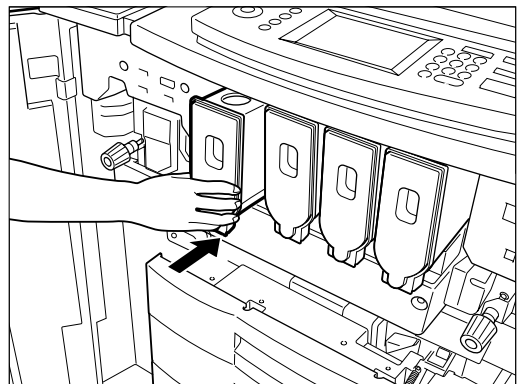

**6** Close the front covers.

- The following message appears:

Wait adding toner

Then the copier automatically starts supplying toner.

- When the toner has finished being supplied, the display panel returns to the Basic menu. (It takes approximately 4 or 5 minutes until the toner has finished being added.)

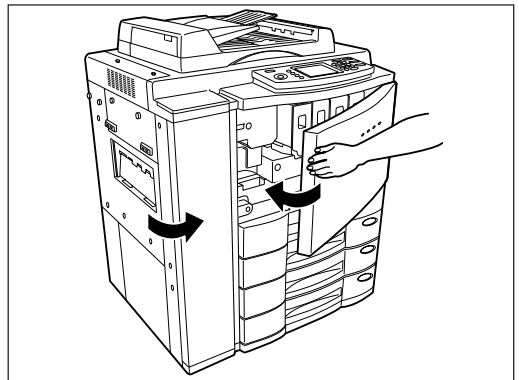

# 4. CLEAR PAPER SYMBOL

When a paper misfeed occurs in the copier, the CLEAR PAPER  symbol flashes and the following message will appear:

Misfeed in copier  
Press INFO

The CLEAR PAPER  symbol flashes in different positions in the diagram depending on where the paper has misfed. Remove the misfed paper as described below.

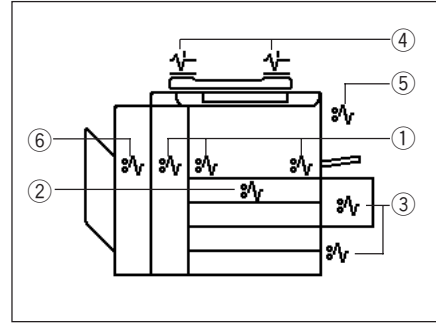

- ① Inside of the Copier
- ② Automatic Duplexer
- ③ Cassettes/Large-Capacity Feeder
- ④ Automatic Document Feeder
- ⑤ Bypass Guide
- ⑥ Staple Sorter

## ① : Misfeeding inside of the Copier

**1** Remove the copy receiving tray.

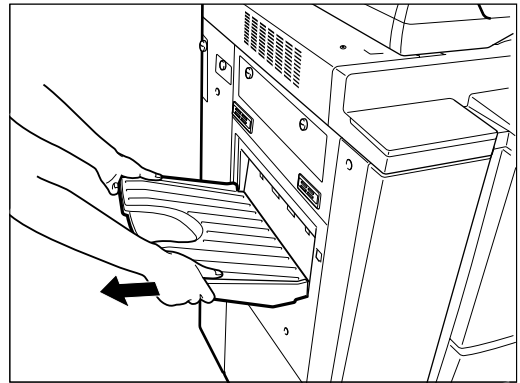

- If a staple sorter is attached, first pull it away from the copier by lifting the release lever.

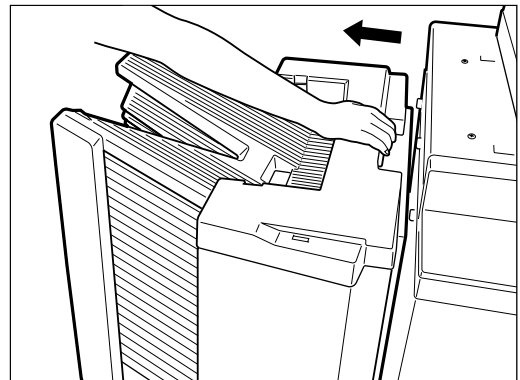

**2** Open the right-hand front cover.

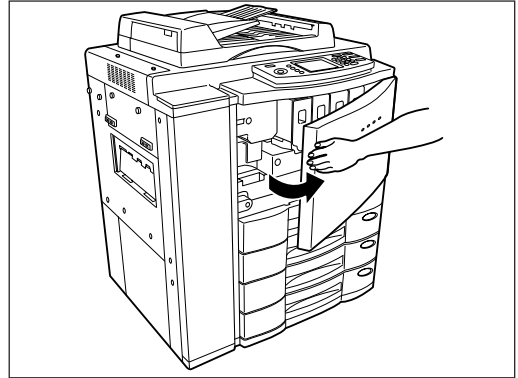

**3** Open the left-hand front cover.

**4** Open the exit cover.

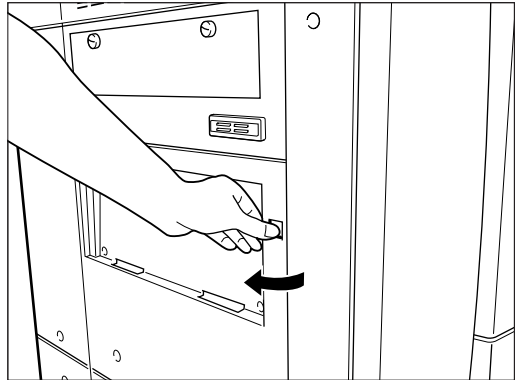

**5** Remove the misfed paper.

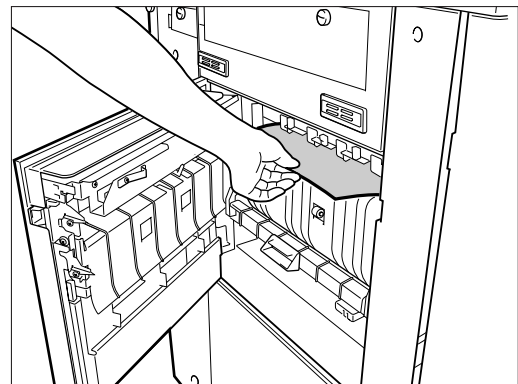

**6** Open the bypass guide.

- Open the bypass guide cover, press the blue button and open the bypass guide.
- Remove any misfed paper.

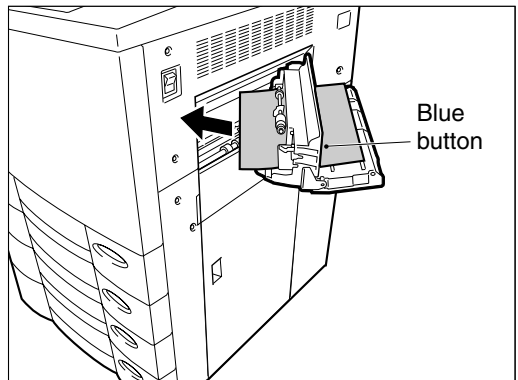

WHEN THE  
GRAPHIC SYMBOLS  
FLASH

## 4. CLEAR PAPER



## SYMBOL (Cont.)

- 7** Turn the knob near the entrance of the transfer belt unit in the direction of the arrow (anticlockwise) and remove any paper that comes out.

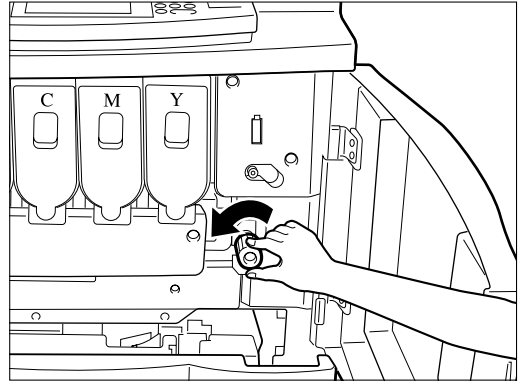

**Tip:** If the CLEAR PAPER symbol flashes as shown on the right, be sure to carry out step 7. If this action is not sufficient, the paper may be torn or it may be left in the copier.

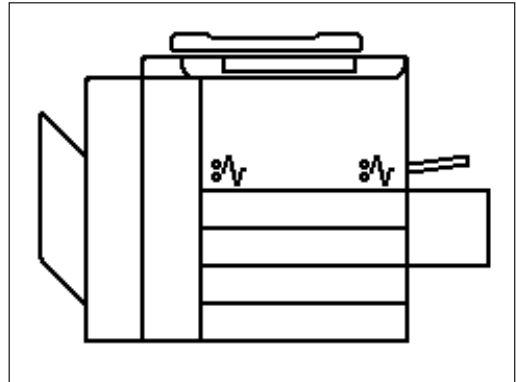

- 8** Turn the knob in the direction of the arrow (clockwise) and pull out the transfer belt unit.

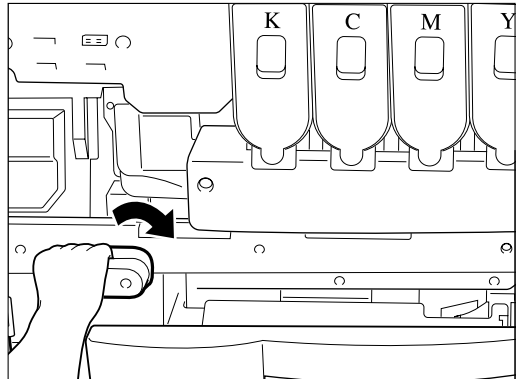

- 9** Remove any misfed paper on the transfer belt.

**Caution:**

Do not touch the drum face and the transfer belt. Touching them may cause image failure.

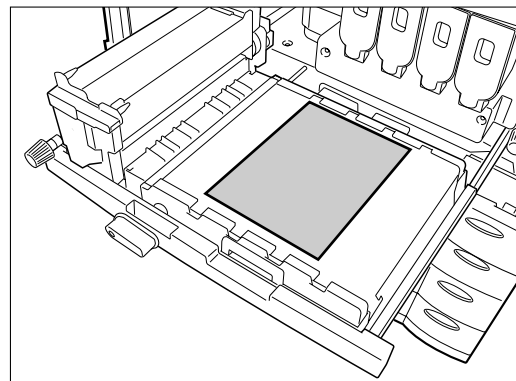



**10** If the misfed paper is gripped between the rollers, remove it by rotating the lever in the direction shown.

**Caution:** Be careful as the fuser and the guide plate around it may be hot.

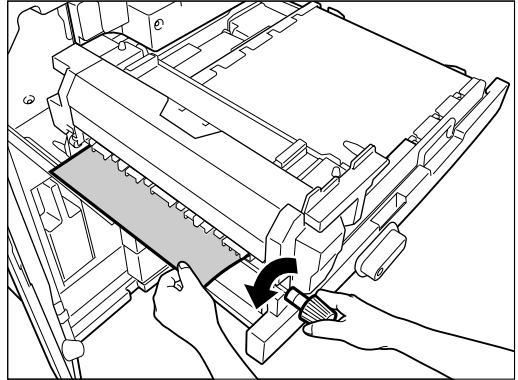

**11** Open the fuser cover and remove any misfed paper.

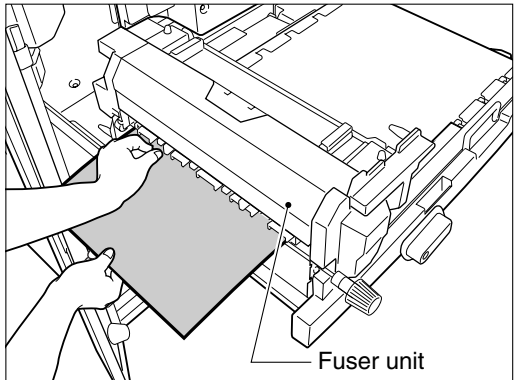

**12** Reinstall the transfer belt unit and turn the knob in the direction shown (anticlockwise) until you hear a click.

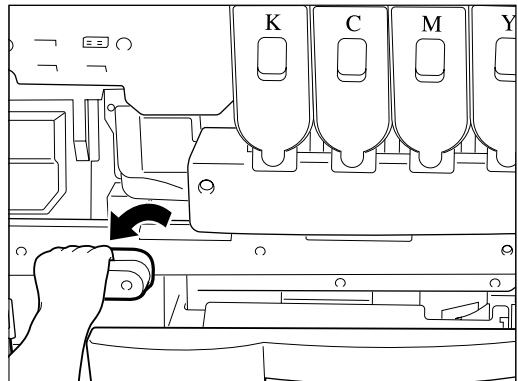

**13** Close the exit cover.

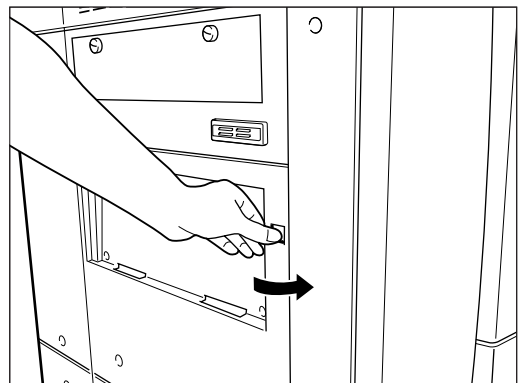

WHEN THE GRAPHIC SYMBOLS FLASH

## 4. CLEAR PAPER 8v SYMBOL (Cont.)

**14** Close the sheet bypass.

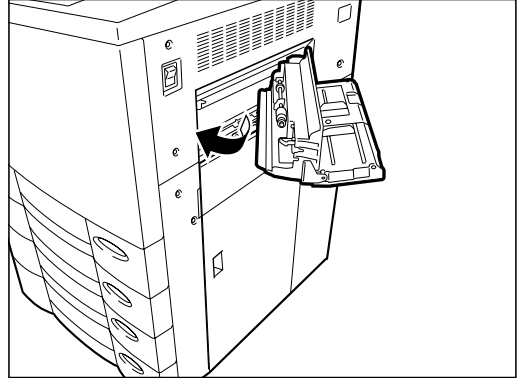

**15** Close the left-hand and right-hand front cover, and reinstall the copy receiving tray or the staple sorter.

## ② : Misfeeding in the Automatic Duplexer

- 1 Remove the copy receiving tray.**
  - If a staple sorter is attached, first pull it away from the copier by lifting the release lever.

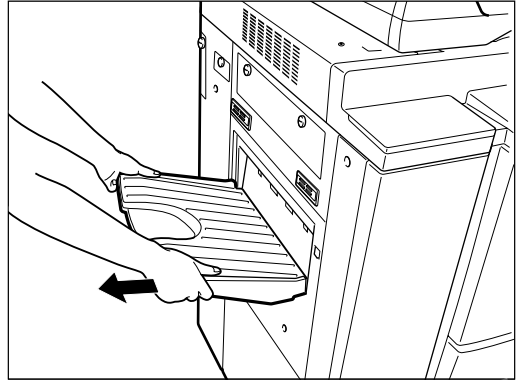

- 2 Open the exit cover and remove any misfed paper.**

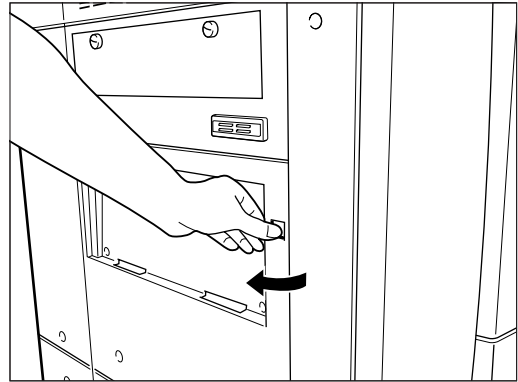

- 3 Lower the lower guide of exit side and remove any misfed paper.**

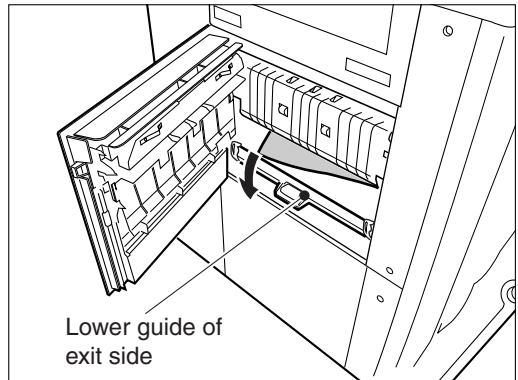

- 4 Close the exit cover.**
- 5 Reinstall the copy receiving tray or the staple sorter.**

WHEN THE GRAPHIC SYMBOLS FLASH

## 4. CLEAR PAPER



## SYMBOL (Cont.)

**6** Pull out the automatic duplexer slowly until it comes to a stop.

**Caution:** Be careful as the metal part of the guide plate of the automatic duplexer may be hot.

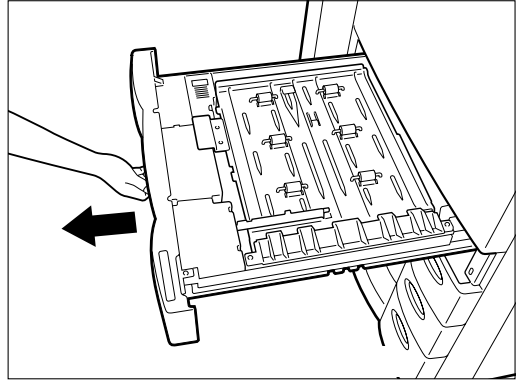

**7** Holding the handle of the upper guide plate, lift it slowly and fully.

- Be careful not to allow the guide plate to drop.
- Remove any misfed paper.

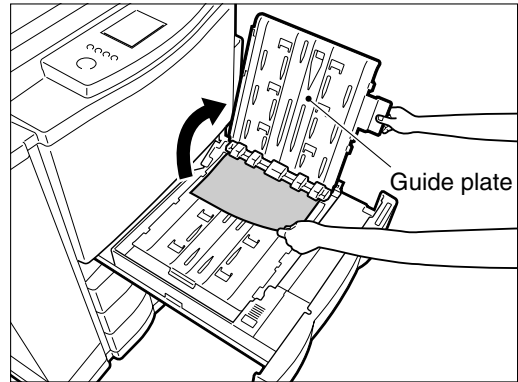

**8** Push the lever, and then holding the handle of the lower guide plate, lift it slowly and fully.

- Make sure that the guide plate is latched to prevent it from dropping.

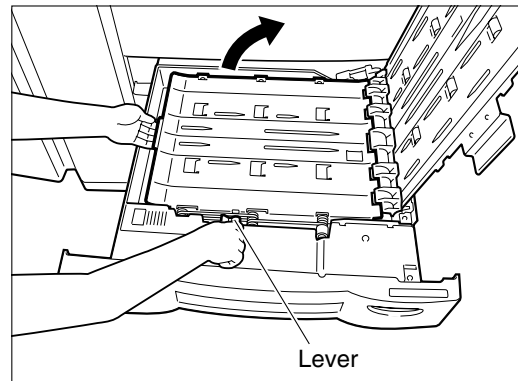

**9** Close the lower guide plate.

- Holding its handle with your right hand, lift the lever up to unlatch the guide plate and lower it slowly.

**10** Lower the upper guide plate slowly.

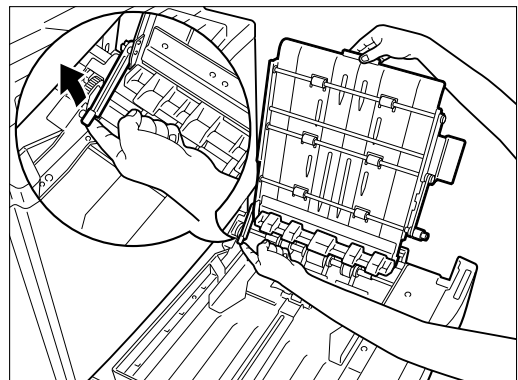

**11** Push in the automatic duplexer slowly and fully.

### ③ : Misfeeding from the Cassettes

**1** Holding its handle, open the feed side cover slowly.

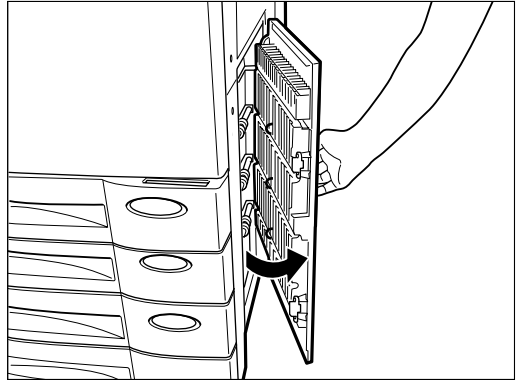

**2** Remove any misfed sheets of paper.

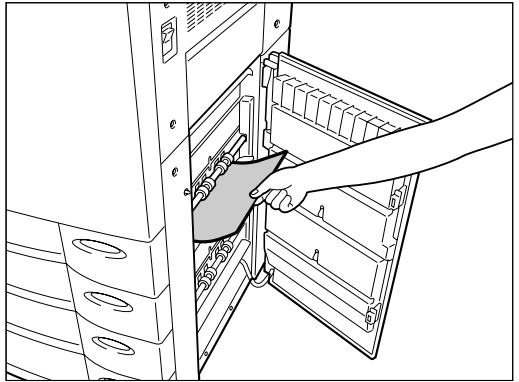

**3** Close the feed side cover.

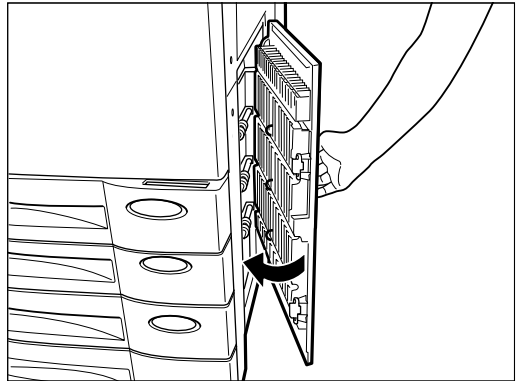

WHEN THE  
GRAPHIC SYMBOLS  
FLASH

# 4. CLEAR PAPER SYMBOL (Cont.)

## ③ : Misfeeding in the Large-Capacity Feeder

- 1 Open the large-capacity feeder.**
  - Holding its handle as shown, lift it to unlock it and open the feeder slowly away from the copier.

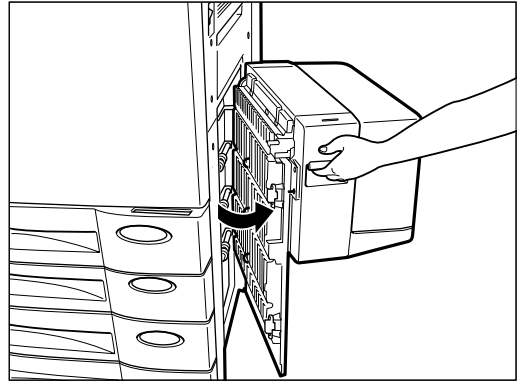

- 2 Remove any misfed sheets of paper from the feeder as shown.**

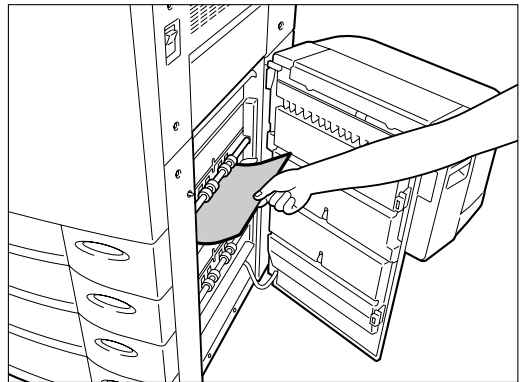

- 3 Close the large-capacity feeder slowly and fully.**

- 4 Open the large-capacity feeder cover slowly and remove any misfed paper from inside.**

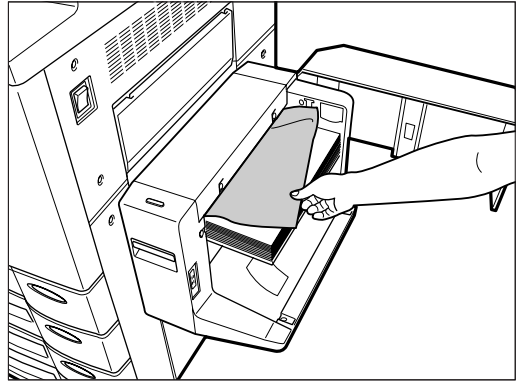

- 5 Close the feeder cover slowly.**

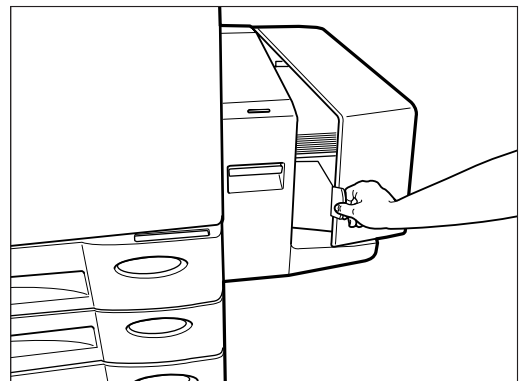

## ④ : Misfeeding in the Automatic Document Feeder

**1** Open the feed-side cover of the automatic document feeder and remove any misfed original.

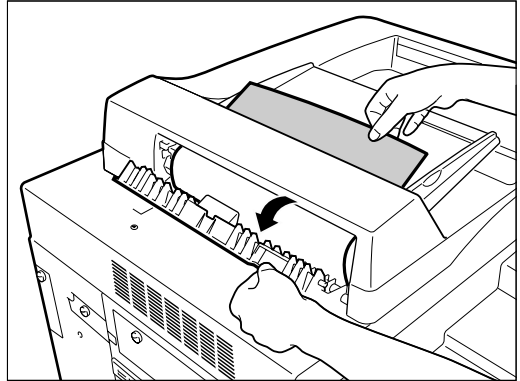

**2** Raise the automatic document feeder and remove any misfed original.  
• If an original is left on the glass, remove it.

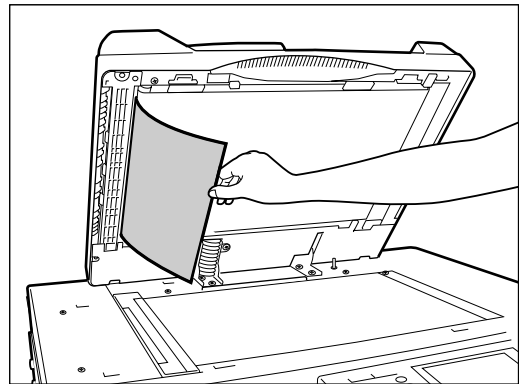

**3** Close the feed-side cover.

**4** Close the automatic document feeder and remove the originals.

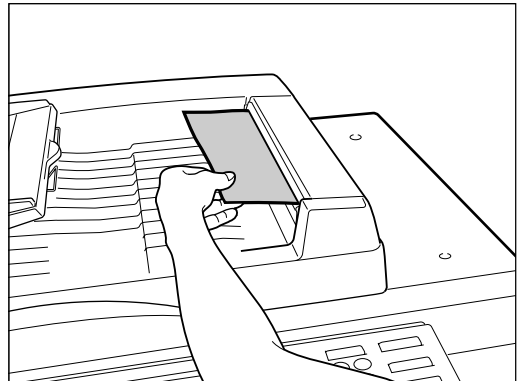

WHEN THE  
GRAPHIC SYMBOLS  
FLASH

**5** Open the exit cover of the automatic document feeder and remove any foreign matter such as bits of paper, paper clips, etc.

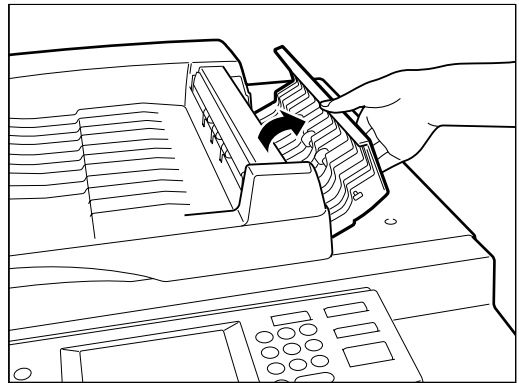

**6** Raise the automatic document feeder and remove any misfed paper.

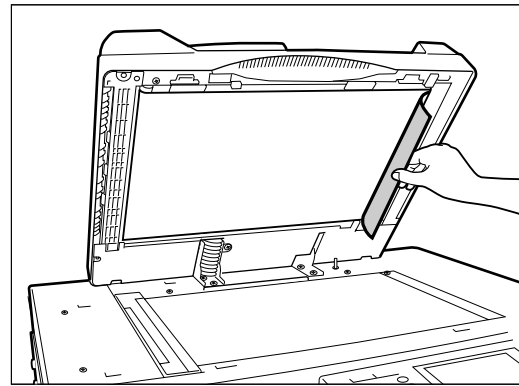

**7** Close the automatic document feeder.

**8** Reset any originals not copied under the originals remaining in the original feed tray and resume copying.

## ⑤ : Misfeeding in the Bypass Guide

**1** Remove all the sheets in the bypass guide.

**2** Align the edges of the sheets, and set them again on the bypass guide.

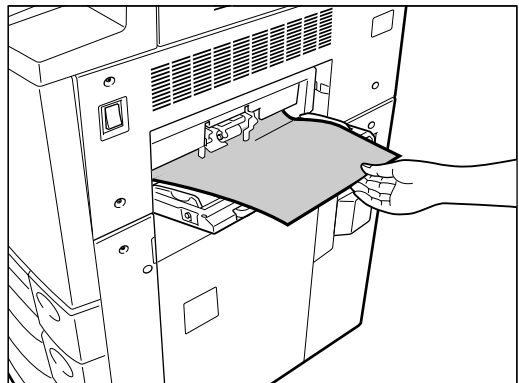



## ⑥ : Misfeeding in the Staple Sorter

**1** Remove any misfed paper in the staple sorter bins.

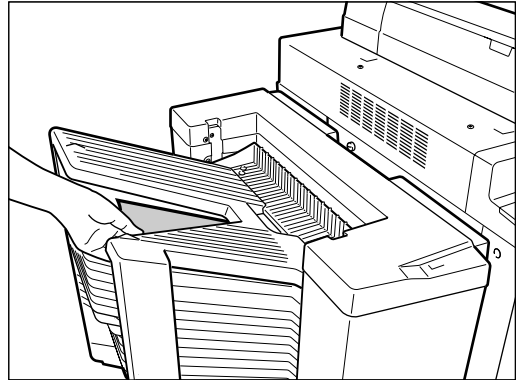

**2** Lift the release lever and move the staple sorter slowly away from the copier.

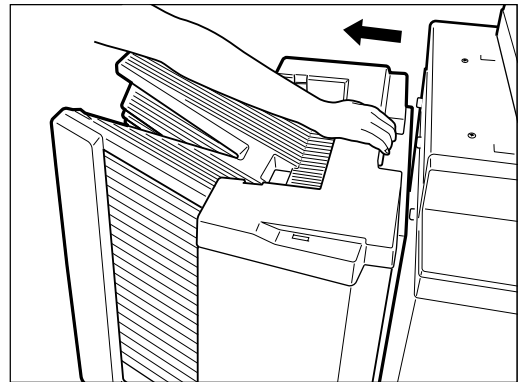

**3** Pull open the paper transport guide of the staple sorter and remove the misfed paper.

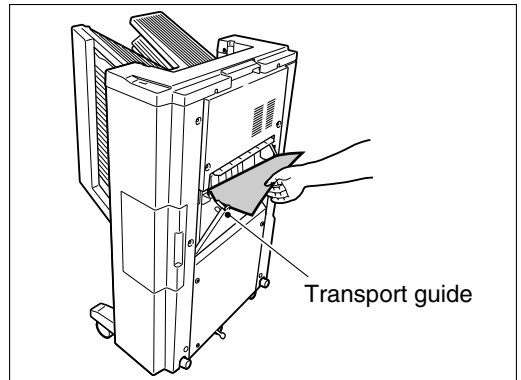

**4** Close the paper transport guide and return the staple sorter to its original position.

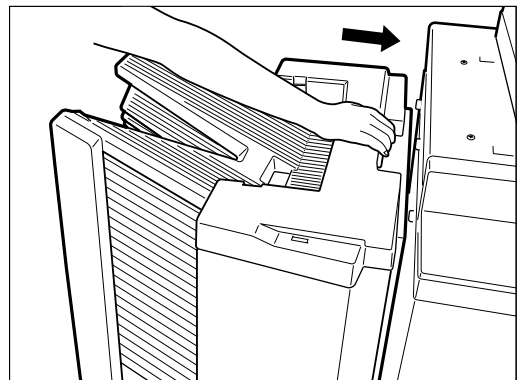

# 5. REPLACING STAPLES

The STAPLE  symbol flashes on the staple sorter when the following occur:

- The stapler of the staple sorter has run out of staples and this message appears:

Set staple cartridge

- A staple has jammed in the stapler and this message appears:

Examine stapler

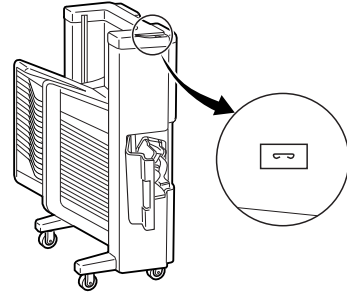

## Replacing Staples

- 1 **Open the stapler cover.**

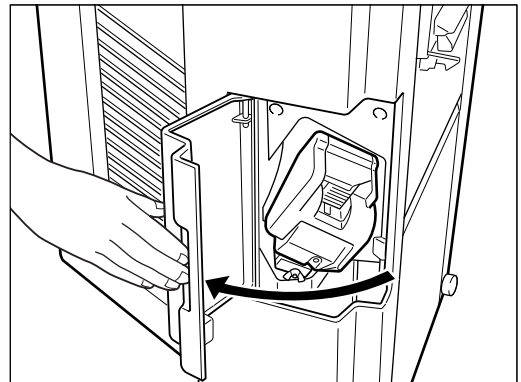

- 2 **Remove the empty staple cartridge**
  - Lift the cartridge slightly and slide it out.

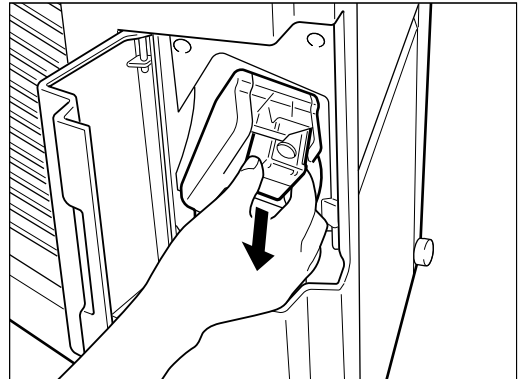

### 3 Install a new staple cartridge.

- First remove the cap from the new staple cartridge.

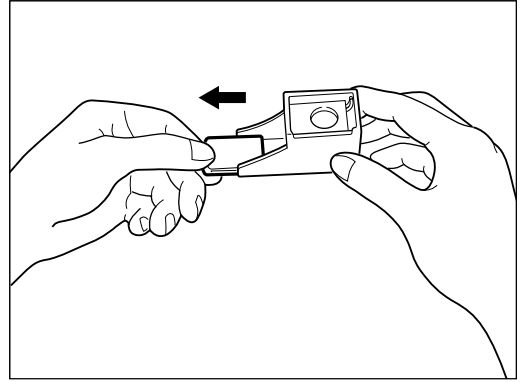

- Slide the new staple cartridge fully into the stapler.

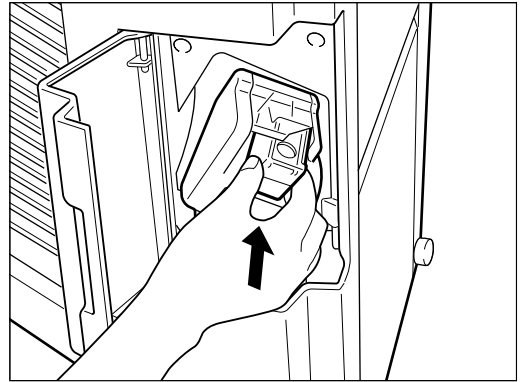

### 4 Close the stapler cover.

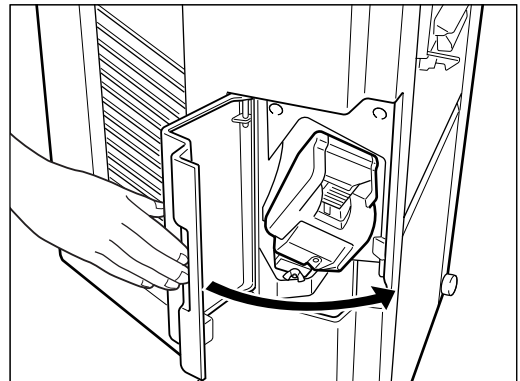

### 5 After replacing the staple cartridge, make sure that the stapler operates correctly by stapling a few sheets of paper as operation test, referring to "Manual Stapling" on page 127.

- If the stapler does not operate correctly, carry out test stapling 7 times until it operates correctly.  
If the stapler still does not operate correctly, reset the staple cartridge.

**Note:** Do not remove the staple cartridge except when you replace it with a new one.

# 6. REMOVING JAMMED STAPLES

## Removing Jammed Staples

**1** Turn OFF the power switch of the copier and open the stapler cover and loosen the wing nut that holds the stapler unit in place.

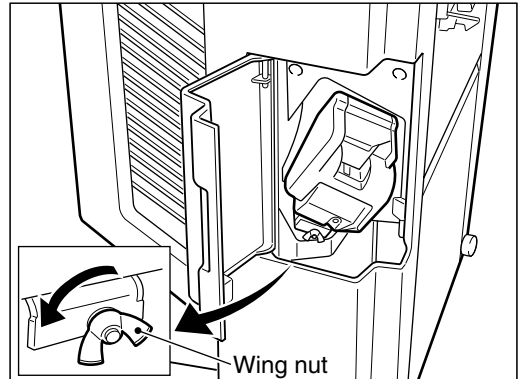

**2** Holding the stapler unit as shown, lift its outer side slightly (arrow ①) and take it out slowly toward you (arrow ②).

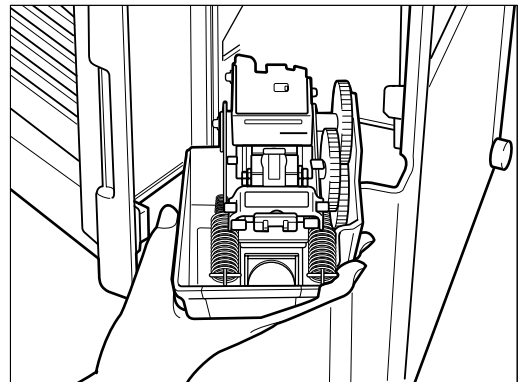
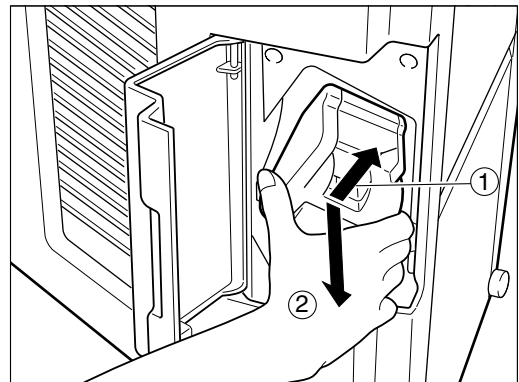

**3** Holding the stapler unit with your one hand, push down the lever with your other hand and hold it there.

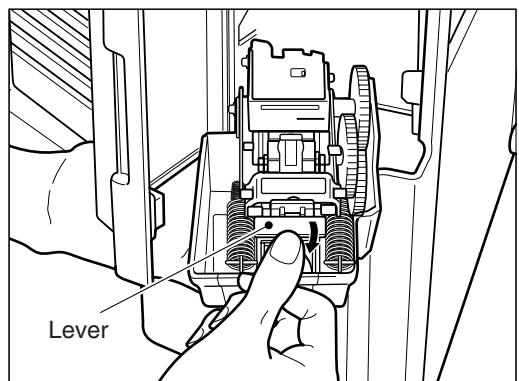

**4** Pull out the slider fully toward you (arrow).

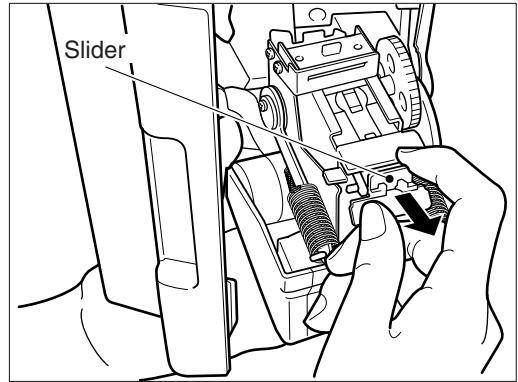

**5** Remove the jammed staple.

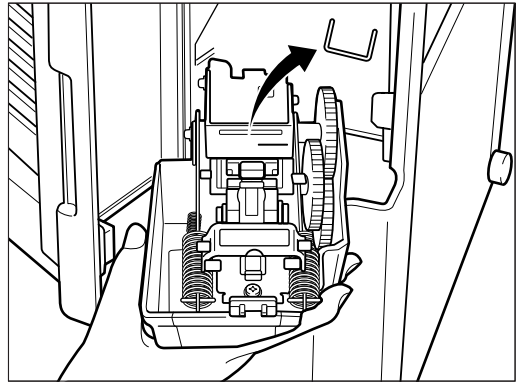

**6** Push the slider fully in.  
• Make sure that the lever has moved up to latch the slider. If not, pull the lever up by hand.

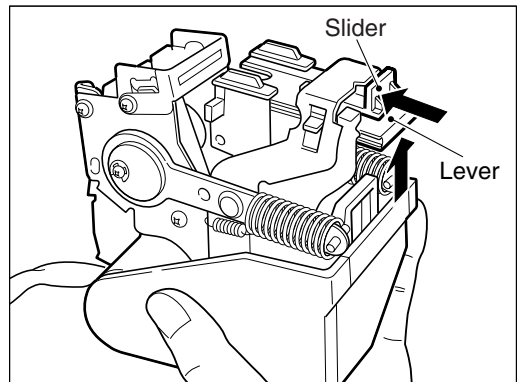

**7** Replace the stapler unit in the staple sorter and tighten the wing nut. Close the stapler cover.

**8** Remove the remaining sheets from the staple sorter and turn ON the power switch.

**9** Referring to page 127 "Manual Stapling", staple a few sheets of paper manually to check that stapling is performed correctly.

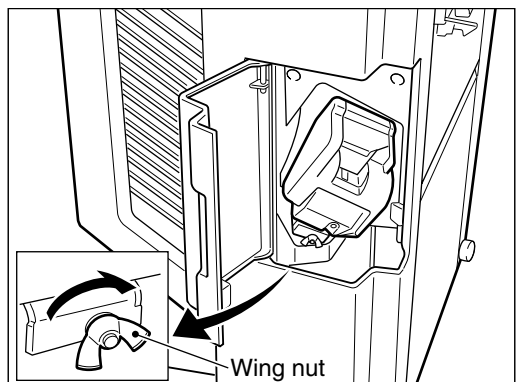

WHEN THE  
GRAPHIC SYMBOLS  
FLASH

## 7. CALL SERVICE SYMBOL

When the CALL SERVICE  symbol flashes, the following message appears and copying is no longer possible:

Call for service

The telephone number of your service technician will be displayed.

Note it down, then turn the power switch off and immediately call service for assistance.

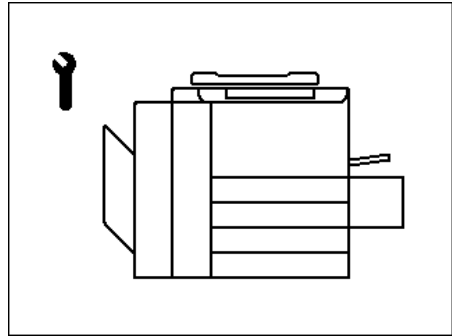

**Note:** Since a heater is used to fix toner images to the copy paper, a safety circuit is incorporated in this copier. After you turn on the power switch, if a certain temperature is not attained within a certain period of time, the safety circuit assumes that something abnormal has happened. This causes the operation of the copier to stop and flashes the CALL SERVICE  symbol. This can possibly occur when the temperature is low but even though the copier is not malfunctioning. If this occurs, turn the power switch off and then on again. Repeat this procedure twice and if the problem still persists, turn off the power switch and call for service.

## 8. PERIODIC MAINTENANCE

**Note:** When the following message appears on the message display:

Time for periodic maintenance (Colour)

or

Time for periodic maintenance (Black)

this indicates that assistance from a qualified service technician is required. Call service for assistance.

# MAINTENANCE

1. Daily Inspection . . . . .	156
2. Simple Troubleshooting . . . . .	157

# 1. DAILY INSPECTION

Items		Countermeasure	Remarks
Items to Inspect Every Day	Power switch ON/OFF status	Press the switch all the way and do not forget to turn ON or OFF the power (Make use of the Auto Power OFF and Weekly Timer as well).	If you are using the copier as a network printer, make sure if you can turn OFF the power before doing so.
Items to Inspect Once A Week	Dirty original glass	Clean the original glass with a cloth moistened with cleaning liquid and wipe it off with a dry cloth.	When cleaning, be careful not to scratch the glass.
	Dirty original cover	Clean the original cover with a cloth moistened with a neutral detergent. Then, wipe off the detergent completely with a dry cloth.	When cleaning, be careful not to scratch the original cover.
	Dirty original transport belt (Reversing automatic document feeder)	Clean the original transport belt of the reversing automatic document feeder with a cloth moistened with a neutral detergent. Then, wipe off the detergent completely with a dry cloth.	When cleaning, be careful not to scratch the belt.



## 2. SIMPLE TROUBLESHOOTING

Status	Items to be Checked	Countermeasure	Reference page
Copier does not start	Is the power cord plug firmly inserted in the outlet?	Insert the power cord plug firmly.	/
	Are the front covers firmly closed?	Close the front covers properly.	→P 8
	Are the bypass feed unit cover and the large-capacity feeder cover firmly closed?	Close the covers properly.	→P 132,138
	Is the exit cover firmly closed?	Close the exit cover properly.	→P 8
Display panel does not change when keys or icons are pressed	Is the copier in the Energy Saving mode?	Press the Energy Saver key to clear the mode. (It takes a while until the copier becomes ready.)	→P 10,20
	Is the ID code input? Is the ID code correct?	Input the correct ID code.	→P 10,107
	Is a key copy counter used?	If you are using a key copy counter, insert it into the slot.	→P 9,117
	Is the "Warming up" message displayed?	Wait until the copier becomes ready.	/
	Does the password of administrator input screen appear?	Password of administrator is required. Ask your copier manager.	→P 94,109
	Is interrupt copying set?	Press the INTERRUPT key to clear the mode.	→P 10,49
Copies are not clear	Is the original cover firmly closed?	Close the cover firmly to shut out any outer light.	/
	Is the original cover or the glass dirty?	Clean the original cover with a cloth moistened with a neutral detergent or the original glass with cleaning liquid. Then, wipe off completely with a dry cloth.	/
	Is the transport belt of the automatic document feeder dirty?	Clean the transport belt with a cloth moistened with a neutral detergent. Then, wipe the detergent completely off with a dry cloth.	/
	Are transparent sheets or double-sided originals used?	The original is transparent and the paper colour or the other side of the original shows through. Set the background lighter.	→P 58
Copy density is too light	Has the "Install new toner cartridge" message appeared?	Install a new toner cartridge.	→P 136
	Is the image density set lighter than standard?	Set the copy density properly in the manual density mode.	→P 36

## 2. SIMPLE TROUBLESHOOTING (Cont.)

Status	Items to be Checked	Countermeasure	Reference page
Copy density is too dark	Is the adjustment of the image density and background set darker than standard?	Set the copy density by manual density mode, or set the background adjustment properly.	→P 36,58
Copy images are blurred	Does the entire original lie properly on the surface of the glass?	Place the original firmly on the glass and close the original cover.	/
	Is the copy paper moist?	Replace with new paper.	
Images are partially missing	Are the original size and direction, and the reproduction ratio suitable for the paper size?	Select the same size of copy paper as the original, or set the reproduction ratio suitable for the paper size.	→P 31,32
	Is the margin on the copy set properly?	Set a smaller image shift value.	→P 62
Functions cannot be set	Are there functions that cannot be combined set together?	Refer to the Function Combination Matrixes in the Operator's Manual and set again.	→P 164,165
Desired colour does not appear	Has the "Install new toner cartridge" message appeared on the display panel?	Install a new toner cartridge.	→P 136
	Has "CALL SERVICE" message appeared on the display panel?	Call your service technician.	→P 154
	Is the copy paper moist?	Replace with new paper.	/
	Is the level of the image density and colour adjustment correct?	Reset the image density and colour adjustment to the standard settings. If colour still deviates slightly, adjust the calibration.	

# SPECIFICATIONS, ACCESSORIES & OPTIONS

1.FC15/22 Specifications . . . . .	160
2.Specifications of Options . . . . .	161
3.Packing List . . . . .	163
4.Copying Function Combination Matrix . . . . .	164
5.Image Quality Adjustment Combination Matrix . . . . .	165

# 1. FC15/22 SPECIFICATIONS

Model Name		FC-15/FC-22
Type		Console type
Original Glass		Fixed
Copying System		Laser electronic copying
Developing System		Dry developing
Fixing System		Heat roller
Photosensor Type		OPC
Original Scanning System		Linear CCD sensor
Resolution/Gradation		Read: 600 dpi/256 gradation
		Write: Corresponding to 9600dpi x 600dpi (Primary scanning only: 16 division smoothing)
Acceptable Originals		Sheets, books and three-dimensional objects
Acceptable Copy Paper Size		Cassette : A3 to A5-R
		Sheet bypass : A3-wide to A5-R
Warm-up Time		Within 9 minutes (Room temperature 20°C) During energy-saving: approx. 5min. or 2min. 30sec.
First Copy Time (A4)		10.3 seconds (Full colour/Black, Manual density)
Continuous Copying Speed (A4)		FC15: 15 copies/min. (Full colour), 22 copies/min. (Black) FC22: 22 copies/min. (Full colour), 22 copies/min. (Black)
Multiple Copying		Up to 999 copies (digital key entry)
Excluded Image Width		Leading edge:5.0mm, Trailing edge:2.5mm, Both edges:2.0mm
Reproduction Ratio		Actual size : 100±0.5%
		Original size : A3, A4, A5, B4, B5
		Paper size : A3, A4, A5, B4, B5
		25 to 400% (in 1% increments) * Independent scaling possible in the adjustment mode.
Paper Supply		Cassette : 600 sheets (64~80g/m <sup>2</sup> ) x 2+600 sheets (64~80g/m <sup>2</sup> ) x 2 (optional)
		Sheet bypass : 50 sheets (64~80g/m <sup>2</sup> )
		Optional large-capacity feeder : 1500 sheets (64~90g/m <sup>2</sup> ), 1250 sheets (91~105g/m <sup>2</sup> )
Toner Density Adjustment		Magnetic auto-toner system
Colour Mode Selection		Full colour, Black, Auto-colour
Original Mode Selection		Text/Photo, Text, Photo, Printed image, Map, Advance image enhancement (Optional)
Image Quality	Density Control	Automatic plus manual selection from 11 density steps
	Image Control	Hue, Saturation, Colour balance, RGB adjustment, Sharpness, Background adjustment, One-touch adjustment
Basic Copy Functions, Special Functions		Automatic paper selection, Automatic magnification selection, Interrupt, Energy save, Auto-clear, Auto shut off, Function clear, Department management, Mode memory, Weekly timer, Date/Time Setting, Auto job start, Automatic duplex copying, OHP cassette feeding/Thick paper cassette feeding, Original counting, Mixed original mode, Change of language, Universal, User selection
Editing Functions		Dual page, Edge erase, Image shift, Book centre erase, Mirror image, Negative/Positive reversal, X-Y zoom, Image repeat, Centring, Trimming, Masking, 2 in 1, 2 in 1 Duplex, Monocolor, Full image
Light Source		Halogen lamp
Power Requirement		220-240V 50/60Hz, 9A
Power Consumption		2.0kW
Dimensions		845mm(W) x 750mm(D) x 1000mm(H)
Weight		Approx. 191kg (not including toner and developer)

## 2. SPECIFICATIONS OF OPTIONS

Automatic Duplexer	MD-5007
Type	Modular (cassette-type)
Acceptable Original Size	Minimum : A5-R
	Maximum : A3
	Paper weight : Plain paper (64~90g/m <sup>2</sup> ) mode only
Maximum Capacity	50 sheets (A4, 64~80g/m <sup>2</sup> ).
	40 sheets (A4, 81~90g/m <sup>2</sup> ).
Dimensions	633mm(W) x 626mm(D) x 110mm(H)
Weight	Approx. 9kg
Power Source	5V, 24V (Supplied from the copier)
Power Consumption	Up to 2.0kW (with the copier)

Reversing Automatic Document Feeder	MR-3006E
Copy Sides	Single-side, Duplex
Number of Originals	Up to 50 originals (A4, 60~90g/m <sup>2</sup> ) 40 originals (A4, 91~105g/m <sup>2</sup> )
Feeding Speed	Approx. 22 originals per minute (A4)
Acceptable Original Size	Minimum : A5-R
	Maximum : A3
	Paper weight : 60~105g/m <sup>2</sup>
Power Source	24V (Supplied from the copier)
Power Consumption	Up to 2.0kW (with the copier)
Dimensions	590mm(W) x 494mm(D) x 120mm(H)
Weight	Approx. 9.5kg

Key Copy Counter	MU-8 (Display, 6 digits), MU-10 (Socket)
------------------	--

\* Specifications and appearance are subject to change without notice.

## 2. SPECIFICATIONS OF OPTIONS (Cont.)

20-bin Staple Sorter	MG-2014
Type	Console, Movable bins
Number of Bins	20bins+Receiving tray
Feeding Mode	Sort, Group, Non-sort, Staple
Bin Capacity	850 sheets (A4)
Non-sort mode (64~105g/m <sup>2</sup> )	750 sheets (A3, FOLIO, A4-R) 250 sheets (A5-R) *If more than 250 sheets are copied, paper exits to the sort bins at first, then the rest exits to the non-sort bin.
Sort mode(64~105g/m <sup>2</sup> )	50 sheets (A4) 25 sheets (A3, FOLIO, A4-R)
Group mode(64~105g/m <sup>2</sup> )	30 sheets (A4) 25 sheets (A3, FOLIO, A4-R)
Paper Type	64~209g/m <sup>2</sup>
Non-sort mode	(length: 100~305mm, width: 148~457mm)
Sort, Group mode	64~105g/m <sup>2</sup>
Stapling Function	Position : One front stapling only Number of copies : 50 sheets (64~80g/m <sup>2</sup> ) 30 sheets (81~90g/m <sup>2</sup> ) 20 sheets (91~105g/m <sup>2</sup> ) *A5-R cannot be stapled.
Power Source	24V (Supplied from the copier)
Power Consumption	Up to 1.5kW (with the copier)
Dimensions	479mm(W) x 597mm(D) x 926mm(H)
Weight	Approx. 38.4kg

Large-Capacity Feeder	MP-1501
Acceptable Paper Weight	Plain paper (64~105g/m <sup>2</sup> )
Acceptable Paper Size	A4
Dimensions	317mm(W) x 460mm(D) x 288mm(H)
Weight	Approx. 8.5kg
Power Source	5V, 24V (Supplied from the copier)
Power Consumption	Up to 2.0kW (with the copier)

AI Board	KR-2030
Dimensions	145mm(W) x 140mm(D) x 10mm(H)
Weight	Approx. 150g
Power Source	3.3V, 5V (Supplied from the copier)
Power Consumption	Up to 2.0kW (with the copier)

\* Specifications and appearance are subject to change without notice.

# 3. PACKING LIST

Packing List	Unpacking/Set-up instructions
	Copy receiving tray
	Operator's manual pocket
	Detachable cords (220-240V only)
	Size mark plate of OHP film

\* Specifications and appearance are subject to change without notice.

# 4. COPYING FUNCTION COMBINATION MATRIX

Function set last / Function set first		Basic settings				Modes		Duplex			Sorting			Editing functions														
		APS	Cassette selection	Sheet bypass selection	AMS selection	Enlarge/Reduce	Original mode selection	Automatic colour selection	1→1	1→2	2→1	2→2	Book→2	Non-sort	Sort	Group	Staple Sort	Image shift	Dual page	2 IN 1 duplex	2 IN 1 duplex	Book erase	XY zoom repeat	Centring	Full image	Mirror	Nega/reversal	Trim/Mask
APS	▲	▲	▲	▲	▲	○	○	○	○	○	○	○	○	○	○	○	○	○	○	○	○	▲	▲	▲	○	○	○	○
Cassette selection	▲	▲	▲	○	○	○	○	○	○	○	○	○	○	○	○	○	○	○	○	○	○	○	○	○	○	○	○	○
Sheet bypass selection	○*1	▲	○	○	○	○	○	○	○	○	○	○	○	○	○	○	○	○	○	○	○	○	○	○	○	○	○	○
AMS	▲	○	○	○	▲	○	○	○	○	○	○	○	○	○	○	○	○	○	○	○	○	○	○	○	○	○	○	○
Enlarge/Reduce	▲	○	○	○	▲	○	○	○	○	○	○	○	○	○	○	○	○	○	○	○	○	○	○	○	○	○	○	○
Original mode selection	○	○	○	○	○	○	○	○	○	○	○	○	○	○	○	○	○	○	○	○	○	○	○	○	○	○	○	○
Automatic colour selection	○	○	○	○	○	○	○	○	○	○	○	○	○	○	○	○	○	○	○	○	○	○	○	○	○	○	○	○
1→1	○	○	○	○	○	○	○	○	○	○	○	○	○	○	○	○	○	○	○	○	○	○	○	○	○	○	○	○
1→2	○	○	○	○	○	○	○	○	○	○	○	○	○	○	○	○	○	○	○	○	○	○	○	○	○	○	○	○
2→1	○	○	○	○	○	○	○	○	○	○	○	○	○	○	○	○	○	○	○	○	○	○	○	○	○	○	○	○
2→2	○	○	○	○	○	○	○	○	○	○	○	○	○	○	○	○	○	○	○	○	○	○	○	○	○	○	○	○
Book→2	○	○	○	○	○	○	○	○	○	○	○	○	○	○	○	○	○	○	○	○	○	○	○	○	○	○	○	○
Non-sort	○	○	○	○	○	○	○	○	○	○	○	○	○	○	○	○	○	○	○	○	○	○	○	○	○	○	○	○
Sort	○	○	○	○	○	○	○	○	○	○	○	○	○	○	○	○	○	○	○	○	○	○	○	○	○	○	○	○
Group	○	○	○	○	○	○	○	○	○	○	○	○	○	○	○	○	○	○	○	○	○	○	○	○	○	○	○	○
Staple Sort	○	○	○	○	○	○	○	○	○	○	○	○	○	○	○	○	○	○	○	○	○	○	○	○	○	○	○	○
Edge erase	○	○	○	○	○	○	○	○	○	○	○	○	○	○	○	○	○	○	○	○	○	○	○	○	○	○	○	○
Image shift	○	○	○	○	○	○	○	○	○	○	○	○	○	○	○	○	○	○	○	○	○	○	○	○	○	○	○	○
Dual page	○	○	○	○	○	○	○	○	○	○	○	○	○	○	○	○	○	○	○	○	○	○	○	○	○	○	○	○
2 IN 1	○	○	○	○	○	○	○	○	○	○	○	○	○	○	○	○	○	○	○	○	○	○	○	○	○	○	○	○
2 IN 1 duplex	○	○	○	○	○	○	○	○	○	○	○	○	○	○	○	○	○	○	○	○	○	○	○	○	○	○	○	○
Book centre erase	○	○	○	○	○	○	○	○	○	○	○	○	○	○	○	○	○	○	○	○	○	○	○	○	○	○	○	○
XY zoom	○	○	○	○	○	○	○	○	○	○	○	○	○	○	○	○	○	○	○	○	○	○	○	○	○	○	○	○
Image repeat	○	○	○	○	○	○	○	○	○	○	○	○	○	○	○	○	○	○	○	○	○	○	○	○	○	○	○	○
Centring	○	○	○	○	○	○	○	○	○	○	○	○	○	○	○	○	○	○	○	○	○	○	○	○	○	○	○	○
Full image	○	○	○	○	○	○	○	○	○	○	○	○	○	○	○	○	○	○	○	○	○	○	○	○	○	○	○	○
Mirror	○	○	○	○	○	○	○	○	○	○	○	○	○	○	○	○	○	○	○	○	○	○	○	○	○	○	○	○
Nega/Posti reversal	○	○	○	○	○	○	○	○	○	○	○	○	○	○	○	○	○	○	○	○	○	○	○	○	○	○	○	○
Trim/Mask	○	○	○	○	○	○	○	○	○	○	○	○	○	○	○	○	○	○	○	○	○	○	○	○	○	○	○	○

○ : The functions can be combined.  
 ▲ : The function set last takes precedence.  
 - : The functions cannot be combined.

\* 1 : Available if paper size is specified.  
 \* 2 : Only A4 is selectable.  
 \* 3 : Sort only (not stapling).  
 \* 4 : Only the cassettes for paper in the R direction are available.



# 5. IMAGE QUALITY ADJUSTMENT COMBINATION MATRIX

Function set		Function set last		Copy density		Colour mode selection						One-touch adjustment			
						Hue	Saturation	Colour balance	RGB	Sharpness	Background	Vivid	Clear	Warm	Cool
Copy density	Manual	Manual	Auto	▲	○	○	○	○	○	○	○	○	○	○	○
	Auto	Auto	Manual	▲	○	○	○	○	○	▲	○	○	○	○	○
Colour mode selection	Hue	Auto	Hue	○	○	○	○	○	○	○	○	○	○	○	○
	Saturation	Auto	Saturation	○	○	○	○	○	○	○	○	○	○	○	○
	Colour balance	Auto	Colour balance	○	○	○	○	○	○	○	○	○	○	○	○
	RGB	Auto	RGB	○	○	○	○	○	○	○	○	○	○	○	○
	Sharpness	Auto	Sharpness	○	○	○	○	○	○	○	○	○	○	○	○
One-touch adjustment	Background	Auto	Background	○	○	○	○	○	○	○	○	○	○	○	○
	Vivid	Auto	Vivid	○	○	○	○	○	○	○	○	○	○	○	○
	Clear	Auto	Clear	○	○	○	○	○	○	○	○	○	○	○	○
	Warm	Auto	Warm	○	○	○	○	○	○	○	○	○	○	○	○
	Cool	Auto	Cool	○	○	○	○	○	○	○	○	○	○	○	○

○ : The functions can be combined.

▲ : The function set last takes precedence.

— : The functions cannot be combined.

# PREVENTATIVE MAINTENANCE

## PREVENTATIVE MAINTENANCE

Toshiba copiers are manufactured to the highest technical standards, using quality parts and components, and are designed to meet all electrical safety and environmental requirements.

To ensure that optimum levels of performance and reliability are maintained, we strongly advise that your copier receives regular visits for Preventative Maintenance at the copy interval prescribed by Toshiba, which is:

### 30,000 copies Main Service

On models which incorporate a periodic maintenance message "TIME FOR PERIODIC MAINTENANCE" on the message display, this message will notify you that preventative maintenance has become necessary, when pre-programmed by your dealer technician.

To ensure that the aforementioned quality standards are maintained, we strongly recommend that only Original Toshiba supplies and parts are used in your copier.

## How to affix the PM labels

The labels have to be replaced by Service Technicians at the time of set up and each PM time.

### To Service Technicians:

At the time of set up and each PM, fill in the appropriate label with the current Total Counter reading, the date and your signature, then peel off and affix the upper part of next PM sticker to the copier as shown.

1. How to fill in the labels:

Compteur		
Date		
Signature		

2. Affixing position

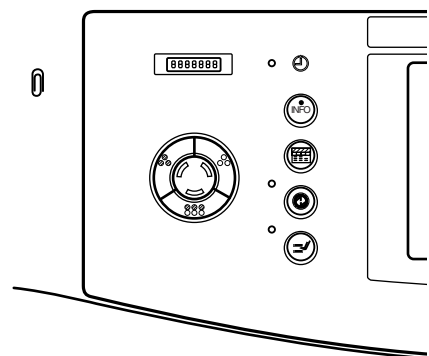

Recycled paper is used for the inside pages of this book.

This Operator's Manual is printed with ink containing soya bean oil.

DIGITAL COLOUR PLAIN PAPER COPIER  
**OPERATOR'S MANUAL**  
**FOR COPYING FUNCTIONS**  
**FC15/22**



# **TOSHIBA TEC CORPORATION**

1-1, KANDA NISHIKI-CHO, CHIYODAKU, TOKYO, 101-8442, JAPAN